

JVC

GR-SXM607
GR-SXM55

COMPACT
VHS CAMCORDER

GR-SXM607 GR-SXM55

JVC
VICTOR COMPANY OF JAPAN, LIMITED

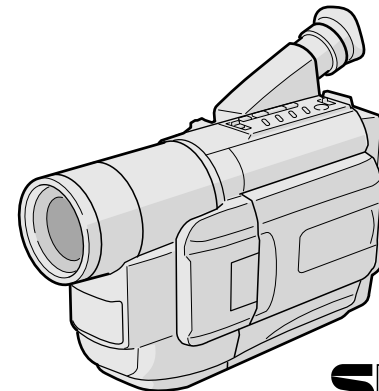

SVHS VHS
PAL
625

Super VHS
Super VHS ET

ENGLISH

CONTENTS

SAFETY PRECAUTIONS	2 - 3
AUTOMATIC DEMONSTRATION	4
PROVIDED ACCESSORIES	4
GETTING STARTED	6 - 13
RECORDING	14 - 29
Basic Recording	14
Basic Features	16
Zooming, Picture Stabilizer, Quick Review, Video Light, Retake	
Advanced Features	18
Snapshot, Night-Scope, Fade/Wipe Effects, Program AE with Special Effects, Digital Effects, Using Menu For Detailed Adjustment, Date/Time Insert, Instant Titles, Animation, Time-Lapse, Exposure Control, Focusing, White Balance Adjustment, Manual White Balance Operation	
PLAYBACK	30 - 34
Basic Playback	30
Features	31
Connections	32
Using The Cassette Adapter	34
USING THE REMOTE CONTROL UNIT (GR-SXM607 only)	35 - 43
Playback Zoom	37
Animation And Time-Lapse	37
Insert Editing	38
Audio Dubbing	39
Random Assembly Editing	40
DETAILS	44
CAUTIONS	45 - 47
TROUBLESHOOTING	48 - 49
INDEX	50 - 53
Controls, Connectors And Indicators	50
Indications	52
TERMS	54
SPECIFICATIONS	55

Dear Customer,

Thank you for purchasing the JVC Compact VHS camcorder. Before use, please read the safety information and precautions contained in the following pages to ensure safe use of this product.

Using This Instruction Manual

- All major sections and subsections are listed in the Table Of Contents on the cover.
- Notes appear after most subsections. Be sure to read these as well.
- Basic and advanced features/operation are separated for easier reference.

It is recommended that you . . .

- refer to the Index (☞ pgs. 50 – 53) and familiarize yourself with button locations, etc. before use.
- read thoroughly the Safety Precautions. They contain extremely important information regarding the safe use of this product.

You are recommended to carefully read the cautions on pages 45 – 47 before use.

SAFETY PRECAUTIONS

IMPORTANT**Connection to the mains supply in the United Kingdom.****DO NOT cut off the mains plug from this equipment.**

If the plug fitted is not suitable for the power points in your home or the cable is too short to reach a power point, then obtain an appropriate safety approved extension lead or consult your dealer.

BE SURE to replace the fuse only with an identical approved type, as originally fitted, and to replace the fuse cover.

If nonetheless the mains plug is cut off be sure to remove the fuse and dispose of the plug immediately, to avoid possible shock hazard by inadvertent connection to the mains supply.

If this product is not supplied fitted with a mains plug then follow the instructions given below:

DO NOT make any connection to the Larger Terminal coded E or Green.

The wires in the mains lead are coloured in accordance with the following code:

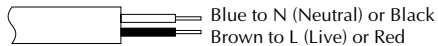

If these colours do not correspond with the terminal identifications of your plug, connect as follows:
Blue wire to terminal coded N (Neutral) or coloured black.

Brown wire to terminal coded L (Live) or coloured Red.
If in doubt — consult a competent electrician.

WARNING:

TO PREVENT FIRE OR SHOCK HAZARD, DO NOT EXPOSE THIS UNIT TO RAIN OR MOISTURE.

CAUTIONS:

- To prevent shock, do not open the cabinet. No user serviceable parts inside. Refer servicing to qualified personnel.
- When you are not using the AC Adapter for a long period of time, it is recommended that you disconnect the power cord from AC outlet.

NOTES:

- The rating plate (serial number plate) and safety caution are on the bottom and/or the back of the main unit.
- The rating information and safety caution of the AC Adapter are on its bottom.

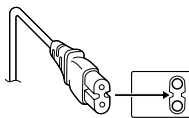
CAUTION:

To avoid electric shock or damage to the unit, first firmly insert the small end of the power cord into the AC Adapter until it is no longer wobbly, and then plug the larger end of the power cord into an AC outlet.

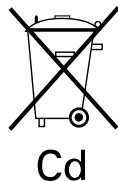
Crossed Out Dust Bin Mark

- The Crossed Out Dust Bin Mark on the battery pack indicates that the product complies with Directives 91/157/EEC and 93/86/EEC.
- Nickel-Cadmium (Ni-Cd) battery pack must be recycled or disposed of properly.



Cassettes marked "S-VHS" and "VHS" can be used with this camcorder.

However, S-VHS recordings are possible only with cassettes marked "S-VHS".

This camcorder is designed to be used with PAL-type colour television signals. It cannot be used for playback with a television of a different standard. However, live recording and LCD monitor/viewfinder playback are possible anywhere. Use the JVC BN-V11U**/V12U/V20U/V400U battery packs and, to recharge them or to supply power to the camcorder from an AC outlet, use the provided multi-voltage AC Adapter. (An appropriate conversion adapter may be necessary to accommodate different designs of AC outlets in different countries.)

*GR-SXM55 only.

When the equipment is installed in a cabinet or on a shelf, make sure that it has sufficient space on all sides to allow for ventilation (10 cm or more on both sides, on top and at the rear).

Do not block the ventilation holes. (If the ventilation holes are blocked by a newspaper, or cloth etc. heat may not be able to get out.)

No naked flame sources, such as lighted candles, should be placed on the apparatus.

When discarding batteries, environmental problems must be considered and local rules or laws governing the disposal of these batteries must be followed strictly.

The apparatus shall not be exposed to dripping or splashing.

Do not use this equipment in a bathroom or places with water.

Also do not place any containers filled with water or liquids (such as cosmetics or medicines, flower vases, potted plants, cups etc.) on top of this unit. (If water or liquid is allowed to enter this equipment, fire or electric shock may be caused.)

Caution on Replaceable lithium battery

The battery used in this device may present a fire or chemical burn hazard if mistreated.

Do not recharge, disassemble, heat above 100°C or incinerate.

Replace battery with Panasonic (Matsushita Electric), Sanyo, Sony or Maxell CR2025.

Danger of explosion or Risk of fire if the battery is incorrectly replaced.

- Dispose of used battery promptly.
- Keep away from children.
- Do not disassemble and do not dispose of in fire.

SOME DO'S AND DON'TS ON THE SAFE USE OF EQUIPMENT

This equipment has been designed and manufactured to meet international safety standards but, like any electrical equipment, care must be taken if you are to obtain the best results and safety is to be assured.

- DO** read the operating instructions before you attempt to use the equipment.
- DO** ensure that all electrical connections (including the mains plug, extension leads and interconnections between pieces of equipment) are properly made and in accordance with the manufacturer's instructions. Switch off and withdraw the mains plug when making or changing connections.
- DO** consult your dealer if you are ever in doubt about the installation, operation or safety of your equipment.
- DO** be careful with glass panels or doors on equipment.
- DON'T** continue to operate the equipment if you are in any doubt about it working normally, or if it is damaged in any way — switch off, withdraw the mains plug and consult your dealer.
- DON'T** remove any fixed cover as this may expose dangerous voltages.
- DON'T** leave equipment switched on when it is unattended unless it is specifically stated that it is designed for unattended operation or has a standby mode. Switch off using the switch on the equipment and make sure that your family knows how to do this. Special arrangements may need to be made for infirm or handicapped people.
- DON'T** use equipment such as personal stereos or radios so that you are distracted from the requirements of road safety. It is illegal to watch television whilst driving.
- DON'T** listen to headphones at high volume, as such use can permanently damage your hearing.
- DON'T** obstruct the ventilation of the equipment, for example with curtains or soft furnishings. Overheating will cause damage and shorten the life of the equipment.
- DON'T** use makeshift stands and NEVER fix legs with wood screws — to ensure complete safety always fit the manufacturer's approved stand or legs with the fixings provided according to the instructions.
- DON'T** allow electrical equipment to be exposed to rain or moisture.

ABOVE ALL

- NEVER let anyone especially children push anything into holes, slots or any other opening in the case — this could result in a fatal electrical shock;
- NEVER guess or take chances with electrical equipment of any kind — it is better to be safe than sorry!

AUTOMATIC DEMONSTRATION

Automatic Demonstration takes place when "DEMO MODE" is set to "ON" (factory-preset).

- Available when the Power Switch is set to "A" or "M".
- Operating the Power Zoom Lever during the demonstration stops the demonstration temporarily. If the Power Zoom Lever is not moved for more than 1 minute after that, the demonstration will resume.
- "DEMO MODE" remains "ON" even if the camcorder power is turned off.
- To cancel Automatic Demonstration, set the Power Switch to "M" and press **MENU** while the demo is in progress. This takes you directly to the demo mode's Setting Menu (so you will not have to go through the main Menu Screen). Rotate **MENU** to select "OFF" and press it.

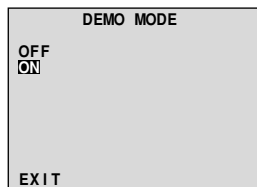

Setting Menu

NOTE:

When a tape whose Erase Protection tab is in the position that allows recording is loaded in the camcorder, demonstration is not available.

PROVIDED ACCESSORIES



• AC Adapter
AP-V10EG

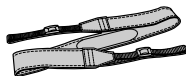

• Shoulder Strap



• Power Cord



• Lens Cap



• Remote Control Unit RM-V715U
(GR-SXM607 only)



• Cable Adapter

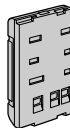

• Battery Pack
BN-V11U (GR-SXM55)
BN-V20U (GR-SXM607)



• Core Filter x 4
(for provided A/V Cable,
S-Video Cable and AC Adapter)



• AAA (R03) Battery x 2
(for Remote Control Unit,
GR-SXM607 only)

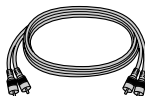

• A/V (Audio/Video) Cable

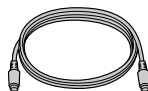

• S-Video Cable

How To Attach The Core Filter

Attach the provided Core Filter to the provided A/V Cable, S-Video Cable and AC Adapter. The Core Filter reduces interference.

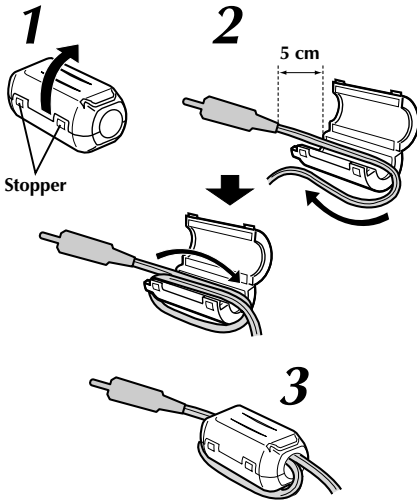

1 Release the stoppers on both ends of the Core Filter.

2 Run the cable through the Core Filter, leaving approx. 5 cm of cable between the cable plug and the Core Filter. Wind the cable around the outside of the Core Filter as shown in the illustration.

- Wind the cable so that it is not slack.

NOTE:

Take care not to damage the cable.

3 Close the Core Filter until it clicks shut. Connect the end of the cable with the Core Filter to the camcorder.

With the provided AC Adapter, attach Core Filters to both ends of the cable as shown below.

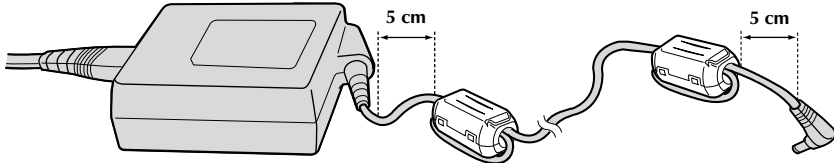

How To Attach The Lens Cap

To protect the lens, attach the provided lens cap to the camcorder as shown in the illustration.

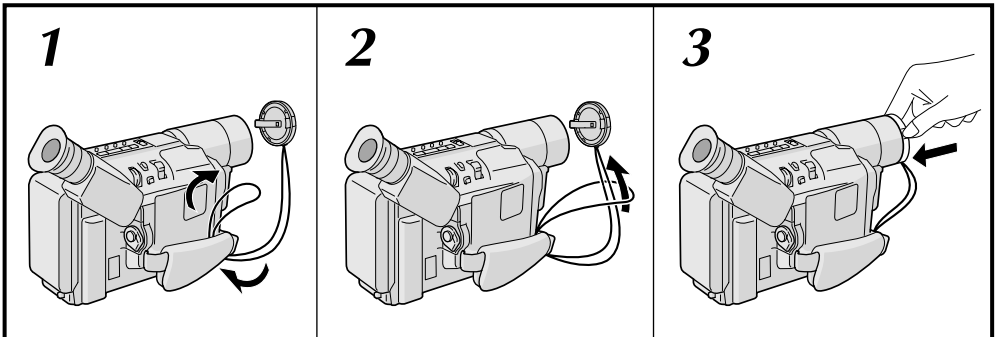

Power

This camcorder's 2-way power supply system lets you choose the most appropriate source of power. Do not use provided power supply units with other equipment.

CHARGING THE BATTERY PACK

- 1** Make sure the battery pack is attached to the camcorder. Hook its end to the camcorder ① and push the battery in until it locks in place ②.
 - If the battery pack is attached in the wrong position, a malfunction may occur.
- 2** Set the Power Switch to "OFF". Connect the AC Adapter to the camcorder ③, then connect the Power Cord to the AC Adapter ④.
- 3** Plug the Power Cord into an AC outlet ⑤. The CHARGE lamp on the camcorder blinks to indicate charging has started.
- 4** When the CHARGE lamp stops blinking but stays lit, charging is finished. Unplug the Power Cord from the AC outlet. Disconnect the AC Adapter from the camcorder.

To Detach The Battery Pack . . .

.... slide **BATTERY RELEASE** and pull out the battery pack.

NOTES:

- During charging or discharging, the camcorder cannot be operated.
- Charging and discharging is not possible if the wrong type of battery is used.
- When charging the battery pack for the first time or after a long storage period, the CHARGE lamp may not light. In this case, remove the battery pack from the camcorder, then try charging again.
- If the battery operation time remains extremely short even after having been fully charged, the battery is worn out and needs to be replaced. Please purchase a new one.
- Using the optional AA-V15EK AC Power Adapter/Charger, you can charge the BN-V11U/V12U/V20U/V400U battery pack without the camcorder. However, it cannot be used as an AC adapter.

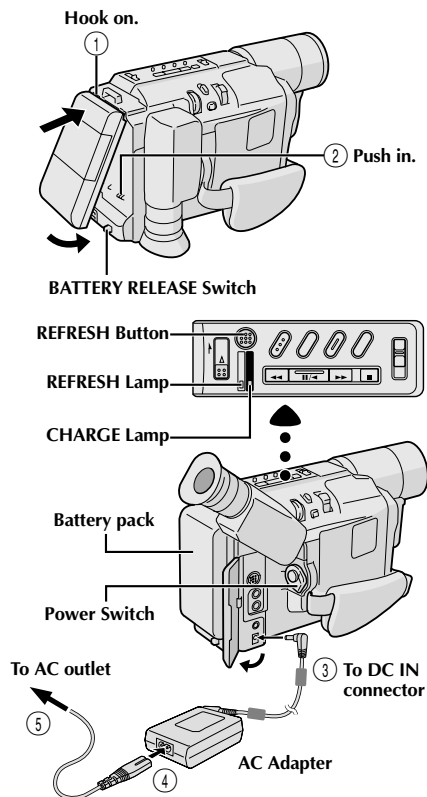

Battery pack	Charging time
BN-V11U*	approx. 1 hr. 10 min.
BN-V12U (optional)	approx. 1 hr. 10 min.
BN-V20U** (optional)	approx. 1 hr. 50 min.
BN-V400U (optional)	approx. 3 hrs. 40 min.

* GR-SXM55 only.

** Provided with GR-SXM607 only.

REFRESH:

Charging a battery with some charge remaining reduces that battery's capacity. Perform the procedure below to fully discharge the battery pack before recharging.

1. Perform steps 1 through 3 of "CHARGING THE BATTERY PACK".
2. Press **REFRESH** on the camcorder for over 2 seconds. The REFRESH lamp on the camcorder blinks to indicate discharging has started.
3. When discharging is finished, charging automatically starts and the CHARGE lamp blinks.

When you are not using a battery pack for a long period of time, be sure to fully discharge it before storing because leaving a battery with some charge left over also reduces performance.

ATTENTION:

Before detaching the power source, make sure that the camcorder's power is turned off. Failure to do so can result in a camcorder malfunction.

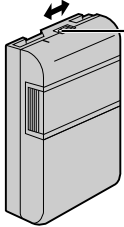
**Charge marker**

A charge marker is provided on the battery pack to help you remember whether it has been charged or not. Two colours are provided (red and black)—you choose which one means charged and which means discharged.

USING THE BATTERY PACK

Perform step 1 of "CHARGING THE BATTERY PACK" (pg. 6).

Approximate recording time (unit: min.)

Battery pack	Viewfinder on	LCD monitor on
BN-V11U	95 (50)	80 (45)
BN-V12U (optional)	95 (50)	80 (45)
BN-V20U (optional)	150 (85)	135 (75)
BN-V400U (optional)	360 (205)	315 (190)

() : when the video light is on (GR-SXM607 only)

NOTES:

- Recording time is reduced significantly under the following conditions:
 - Zoom or Record-Standby mode is engaged repeatedly.
 - The LCD monitor is used repeatedly.
- Before extended use, it is recommended that you prepare enough battery packs to cover 3 times the planned shooting time.

USING AC POWER

Use the AC Adapter (connect as shown in the illustration).

NOTES:

- The provided AC Adapter features automatic voltage selection in the AC range from 110 V to 240 V.
- For other notes, pg. 44.

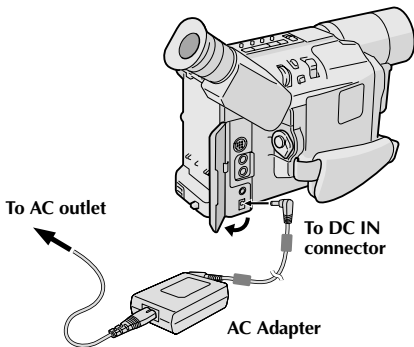

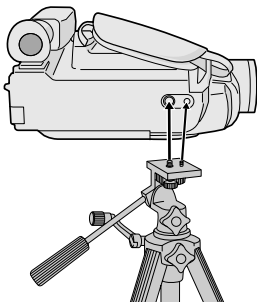
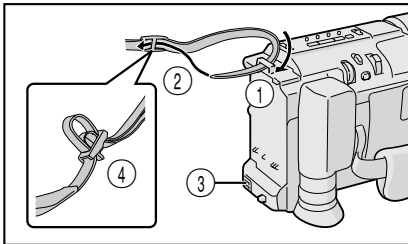
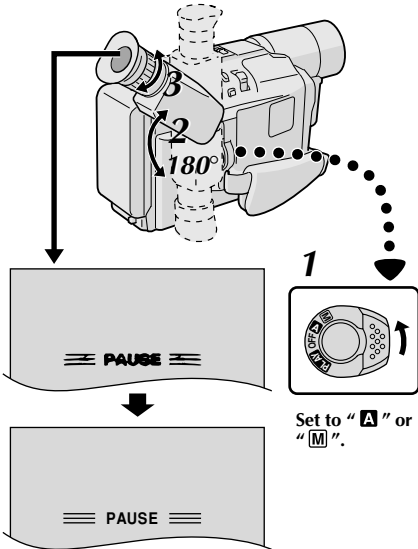
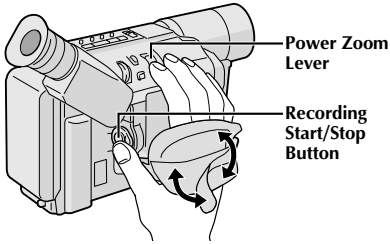

Grip Adjustment

- 1 Separate the Velcro strip.
- 2 Pass your right hand through the loop and grasp the grip.
- 3 Adjust so that your thumb and fingers can easily operate the Recording Start/Stop Button and Power Zoom Lever. Refasten the Velcro strip.

Viewfinder Adjustment

- 1 Set the Power Switch to "A" or "M".
- 2 Adjust the viewfinder manually for best viewability.
- 3 Turn the Dioptre Adjustment Control until the indications in the viewfinder are clearly focused.

Shoulder Strap Attachment

- 1 Following the illustration, thread the strap through the eyelet (1), then fold it back and thread it through the buckle (2). Repeat the procedure to attach the other end of the strap to the other eyelet (3), making sure the strap is not twisted.
- 2 Adjust as shown in the illustration (4).

Tripod Mounting

- 1 Align the screw and camera direction stud on the tripod with the camera's mounting socket and stud hole. Then tighten the screw.

CAUTION:

When using a tripod, be sure to open and extend its legs fully to Stabilize the camcorder. To prevent damage to the unit caused by falling over, do not use a small-sized tripod.

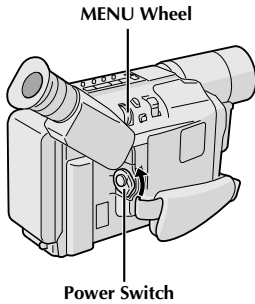

Display

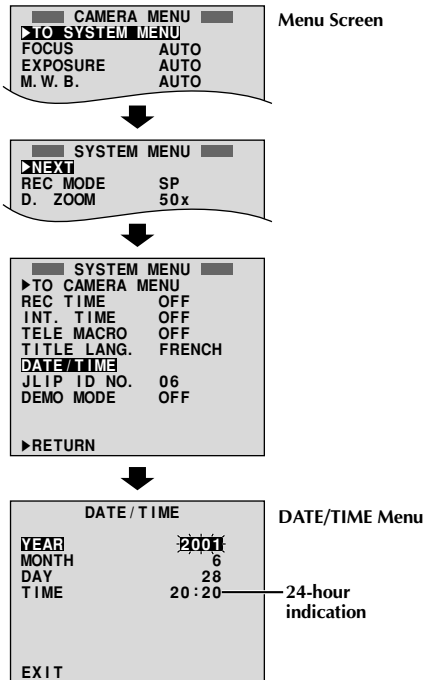

Date/Time Settings

- 1 Set the Power Switch to "M". The power lamp comes on.
- 2 Press **MENU**. The Menu Screen appears.
- 3 Rotate **MENU** to select "▶ TO SYSTEM MENU" and press it to display SYSTEM MENU. Rotate **MENU** to select "▶ NEXT" and press it to display the next page.
- 4 Rotate **MENU** to select "DATE/TIME" and press it. The DATE/TIME Menu appears.
- 5 To set "YEAR", "MONTH", "DAY" or "TIME" (hour/minute), rotate **MENU** to select the desired item, and press it. When the setting begins blinking, rotate **MENU** until the correct setting appears and then press it. The setting stops blinking.
- 6 When none of these settings ("YEAR", "MONTH", "DAY", "TIME") blinks, rotate **MENU** to select "EXIT", and press it. The Menu Screen reappears with the highlight bar on "▶ RETURN".
- 7 Press **MENU** to close the Menu Screen.

NOTE:

To display the date and time in the camcorder's display and on a connected TV, see "Date/Time Insert" (ⓘ pg. 25).

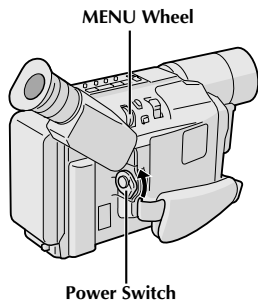

Display: when a VHS cassette is loaded.

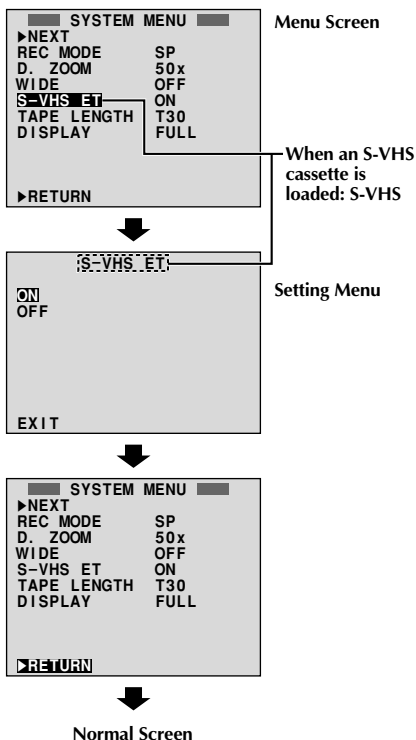

Recording Format Setting

Set the recording format according to the format of the tape used or type of recording you wish to perform.

NOTE:

S-VHS ET recording is not possible when the recording mode is set to "LP".

Before performing the following steps, make sure that the recording mode is set to "SP" (☞ pg. 12).

- 1 Set the Power Switch to "☐". The power lamp comes on.
- 2 Press MENU. The Menu Screen appears.
- 3 Rotate MENU to select "▶ TO SYSTEM MENU" and press it to display SYSTEM MENU.
If a VHS cassette is loaded . . .
 rotate MENU to select "S-VHS ET", then press it. The S-VHS ET Setting Menu appears.
If an S-VHS cassette is loaded . . .
 rotate MENU to "S-VHS", then press it. The S-VHS Setting Menu appears.
- 4 Rotate MENU to set to either of the parameters, then press it. The Menu Screen reappears with the highlight bar on "▶ RETURN".
In the S-VHS ET Setting Menu,
ON : Records with S-VHS picture quality on a VHS cassette (factory-preset). This is called Super VHS ET (Expansion Technology).
OFF : Records in VHS.
In the S-VHS Setting Menu,
ON : Records in S-VHS on an S-VHS cassette (factory-preset).
OFF : Records in VHS on an S-VHS cassette.
- 5 Press MENU to close the Menu Screen.
 - When the S-VHS ET mode is engaged, "S-ET" is displayed.
 - During S-VHS record mode, "S" is displayed.
 - When S-VHS ET or S-VHS recording starts, "S-VHS REC" is displayed for approx. 3 seconds.

NOTE:

If a cassette is not loaded, "S-VHS" will be displayed in the Menu Screen.

NOTES about S-VHS and S-VHS ET

- JVC EHG (Extra High Grade) tapes are recommended for superior results.
Use S-VHS tape for storing recordings for an extended period or for recording important scenes, as it enables higher-quality recording and playback.
— It is recommended to specifically label S-VHS ET recordings so you can easily distinguish them from regular VHS recordings.
- With some tapes, better picture quality may not be obtained even with S-VHS ET recording. It is recommended that you do test record beforehand to make sure whether better results can be obtained.
- If the S-VHS ET mode or recording format is switched during recording, the playback picture will be blurred at the switching point.
- It is recommended that tapes recorded on this camcorder be played back on this camcorder.
- Tapes recorded in S-VHS or S-VHS ET mode can be played back not only on this camcorder but also on a Super VHS VCR.
— Tapes recorded in S-VHS ET mode cannot be played back on some VCRs, including some JVC VCRs.
- Tapes recorded in S-VHS or S-VHS ET mode cannot be played back correctly on a normal VHS VCR.
- S-VHS ET does not work with S-VHS tapes.
- To avoid on-screen noise, do not perform Still Playback or Shuttle Search repeatedly.
- If the picture contains a lot of jitter or noise, use a cleaning cassette.

Compatibility Between S-VHS And VHS

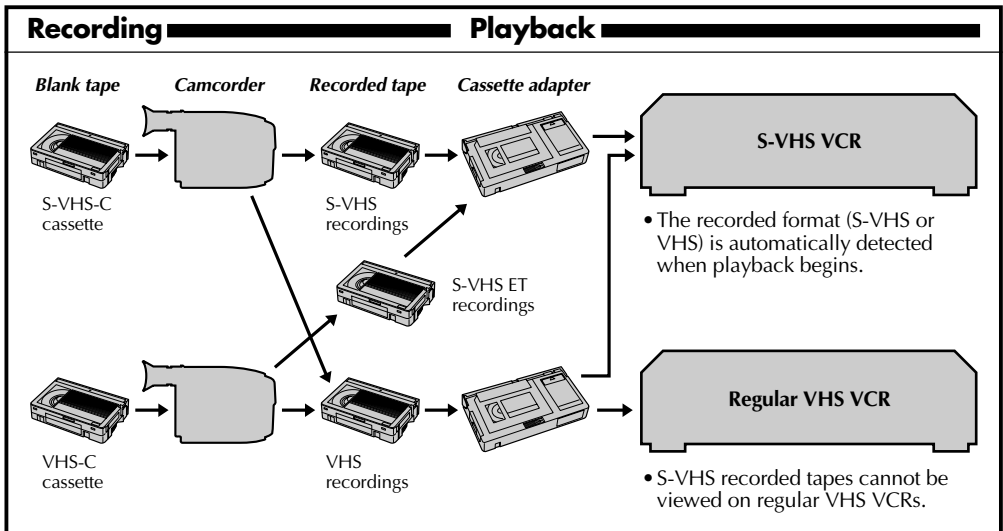

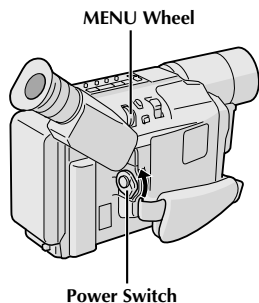

Display

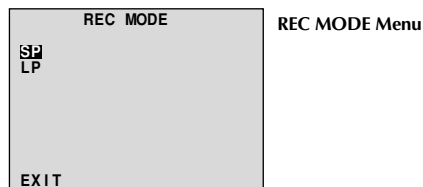

Recording Mode Setting

Set the tape recording mode depending on your preference.

- 1** Set the Power Switch to "M". The power lamp comes on.
- 2** Press **MENU**. The Menu Screen appears.
- 3** Rotate **MENU** to select "▶ TO SYSTEM MENU" and press it to display SYSTEM MENU.
- 4** Rotate **MENU** to select "REC MODE" and press it. The REC MODE Menu appears. Select "SP" or "LP" by rotating **MENU** and press it. The Menu Screen reappears with the highlight bar on "▶ RETURN". Press **MENU** to close the Menu Screen.
 - "LP" (Long Play) is more economical, providing twice the recording time.

NOTE:

If the recording mode is switched during recording, the playback picture will be blurred at the switching point.

Display

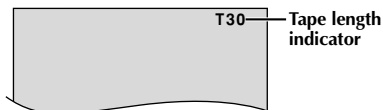
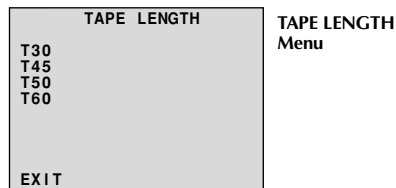

Tape Length Setting

Set the tape length according to the length of the tape used.

- 1** Perform steps 1 through 3 above.
- 2** Rotate **MENU** to select "TAPE LENGTH", then press it. The TAPE LENGTH Menu appears.
- 3** Rotate **MENU** to select the correct tape length setting.
 - T30=30 minutes
 - T45=45 minutes
 - T50=50 minutes
 - T60=60 minutes
- 4** Press **MENU**. The Menu Screen reappears with the highlight bar on "▶ RETURN". Press **MENU** to close the Menu Screen.

NOTE:

The tape remaining time (pg. 14) is correct only if the correct tape length has been selected.

Loading/Unloading A Cassette

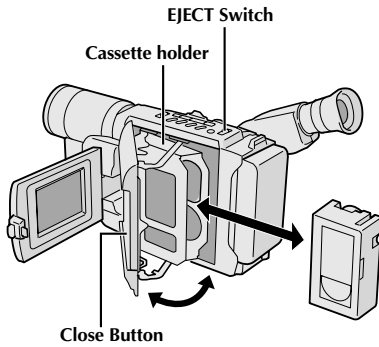

- 1** Open the LCD monitor fully.
- 2** Slide **EJECT** until the cassette holder opens. Do not use force to open.
- 3** Insert or remove a cassette. When inserting, make sure the label is facing outward.
- 4** Press the Close button to close the cassette holder until it locks into place.
- 5** Close the LCD monitor.

NOTES:

- Closing the LCD monitor while the cassette holder is still open may cause damage to the LCD monitor.
- The cassette holder can't be opened unless a power supply is attached.
- Make sure that the tape is not slack when loading the cassette. If there is any slack, turn the gear in the direction of the arrow to take up the slack.
- Make sure the Erase Protection tab is in the position that allows recording. If not, slide the tab. Some cassettes have removable tabs. If the tab has been removed, cover the hole with adhesive tape.
- The cassette holder cannot be opened while the camcorder is in the record mode.

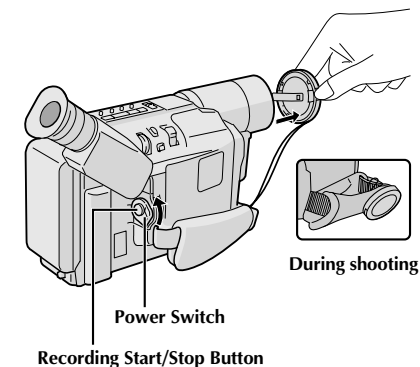

During shooting

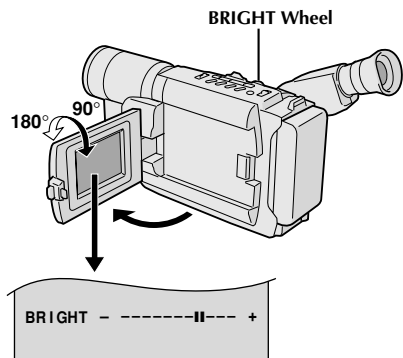
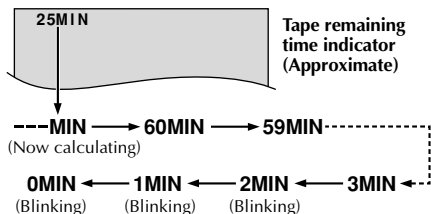

To Adjust The Brightness Of The LCD Monitor

.... rotate **BRIGHT** until the bright level indicator on the display moves and the appropriate brightness is reached.

NOTE:

You should already have performed the procedures listed below. If not, do so before continuing.

- Power (☞ pg. 6)
- Load A Cassette (☞ pg. 13)
- Recording Mode Setting (☞ pg. 12)
- Tape Length Setting (☞ pg. 12)
- Grip Adjustment (☞ pg. 8)
- Viewfinder Adjustment (☞ pg. 8)

Shooting While Watching The Viewfinder

1 Make sure the LCD monitor is closed and locked. Press in the tabs on the lens cap to remove it. Set the Power Switch to "**A**" or "**M**". The power lamp lights and the camcorder enters the Record-Standby mode. "PAUSE" is displayed in the viewfinder.

2 Press the Recording Start/Stop Button. "REC" appears in the viewfinder while recording is in progress.

To Stop Recording . . .

.... press the Recording Start/Stop Button. The camcorder re-enters the Record-Standby mode.

Shooting While Watching The LCD Monitor

1 Make sure the LCD monitor is fully open. Press in the tabs on the lens cap to remove it. Set the Power Switch to "**A**" or "**M**". The power lamp lights and the camcorder enters the Record-Standby mode. "PAUSE" is displayed in the LCD monitor.

2 Tilt the LCD monitor upward/downward for best viewability and press the Recording Start/Stop Button. "REC" appears in the LCD monitor while recording is in progress.

NOTE:

When you use the LCD monitor outdoors in direct sunlight, the LCD monitor may be difficult to see. If this happens, use the viewfinder instead.

To Stop Recording . . .

.... press the Recording Start/Stop Button. The camcorder re-enters the Record-Standby mode.

Power Switch Position

- A** : Suitable for standard recording using NO special effects or manual adjustments.
- M** : Allows you to set recording functions using the menus for more creative capabilities.
- OFF** : Switches off the camcorder.
- PLAY** : Allows you to play back your recordings.

NOTES:

- If the Record-Standby mode continues for 5 minutes without performing Zoom or any other operations, the camcorder's power shuts off automatically. Set the Power Switch to "OFF", and then back to "A" or "M" to turn the camcorder on again.
- If you are recording on a cassette from the middle (such as when a tape is removed and re-inserted during recording), use the Retake function (pg. 17) to find the end of the last recording so you do not erase any of it.
- To remove the indications from the camcorder's display during recording, pg. 22, 24.

**JOURNALISTIC SHOOTING**

In some situations, different shooting angles may provide more dramatic results. Hold the camcorder in the desired position and tilt the LCD monitor in the most convenient direction. It can rotate 270° (90° downward, 180° upward).

SELF-RECORDING

You can shoot yourself while viewing your own image in the LCD monitor. Open the LCD monitor and tilt it upward 180° so that it faces forward, then point the lens toward yourself and start recording.

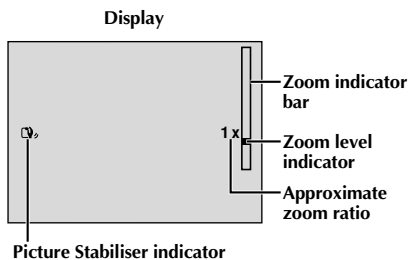
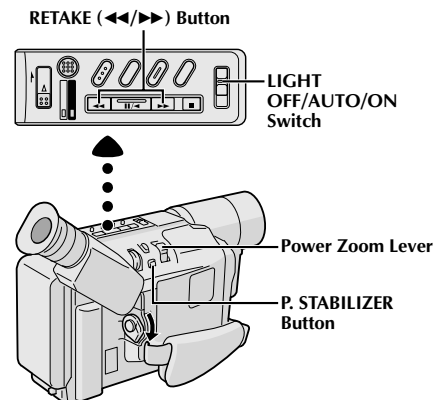
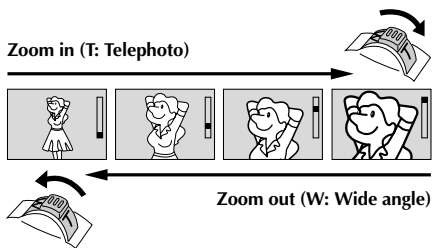

Zooming: To produce the zoom in/out effect, or an instantaneous change in image magnification.

Digital circuitry extends the maximum magnification offered by optical zoom. This system is called Digital Zoom.

Zoom In

Slide the Power Zoom Lever towards "T".

Zoom Out

Slide the Power Zoom Lever towards "W".

- The further you slide the Power Zoom Lever, the quicker the zoom action.
- Focusing may become unstable during Zooming. In this case, set the zoom while in Record-Standby, lock the focus by using the manual focus (☞ pg. 28), then zoom in or out in Record mode.
- The zoom level indicator (■) moves during zoom. Once the zoom level indicator reaches the top of the zoom indicator bar, all magnification from that point is through digital processing.
- When using Digital Zoom, the quality of image may suffer. To deactivate Digital Zoom, set "D.ZOOM" to "OFF" in SYSTEM MENU (☞ pg. 23).
- Digital zoom cannot be used when the "VIDEO ECHO" mode (☞ pg. 21) is activated.

Picture Stabiliser: To compensate for unstable images caused by camera-shake, particularly at high magnification.

- 1) Press **P. STABILIZER**. "☞" appears.
 - 2) To switch off the Picture Stabiliser, press **P. STABILIZER**. The indicator disappears.
- Accurate stabilisation may not be possible if hand shake is excessive, or under the following conditions:
 - When shooting subjects with vertical or horizontal stripes.
 - When shooting dark or dim subjects.
 - When shooting subjects with excessive backlighting.
 - When shooting scenes with movement in various directions.
 - When shooting scenes with low-contrast backgrounds.
 - Switch off the Picture Stabiliser when recording with the camcorder on a tripod.
 - The "☞" indicator appears blinking if the Stabiliser cannot be used.
 - This function cannot be activated during the "Night-Scope" (☞ pg. 18), "CLASSIC FILM", "STROBE" and "VIDEO ECHO" mode (☞ pg. 21).

Quick Review: To check the end of the last recording.

- 1) Make sure the camcorder is in the Record-Standby mode.
- 2) Press ◀◀ and release quickly.
Tape is rewound for approx. 1 second and played back automatically, then pauses in Record-Standby mode for the next shot.
- *Distortion may occur at the start of playback. This is normal.*

Retake: To re-record certain segments.

- 1) Make sure the camcorder is in the Record-Standby mode.
- 2) Press and hold either **RETAKE** to reach the start point for new recording. Pressing ▶▶ forwards the tape and pressing ◀◀ reverses it.
- 3) Press the Recording Start/Stop Button to start recording.
- *Noise bars appear and pictures may become monochrome or darken during Retake. This is normal.*

Video Light (GR-SXM607 only): To brighten the scene when natural lighting is too dim.

1) Set **LIGHT OFF/AUTO/ON** as required:

OFF : Turns off the light.

AUTO : Automatically turns on the light when the camcorder senses insufficient lighting on the subject.

ON : Always keeps the light on as long as the camcorder is turned on.

- *The video light can only be used with the camcorder's power on.*
- *It is recommended to set the white balance (☞ pg. 29) to ☞ when you use the video light.*
- *When not using the video light, turn it off to save battery power.*
- *Even if the battery indicator (☐) does not blink if the battery pack's charge is low, the camcorder may turn off automatically when you turn on the video light, or when you start recording with the video light turned on.*
- *When **LIGHT OFF/AUTO/ON** is set to "AUTO":*
 - *Depending on the lighting conditions, the video light may keep turning on and off. In this case, manually switch the light on or off using **LIGHT OFF/AUTO/ON**.*
 - *While the "Sports" or "High Speed Shutter" mode (☞ pg. 20) is engaged, the light is likely to stay on.*
 - *While the "Twilight" mode (☞ pg. 20) is engaged, the light will not activate.*



DANGER

- The video light can become extremely hot. Do not touch it either while in operation or soon after turning it off, otherwise serious injury may result.
- Do not place the camcorder into the carrying case immediately after using the video light, since it remains extremely hot for some time.
- When operating, keep a distance of about 30 cm between the video light and people or objects.
- Do not use near flammable or explosive materials.
- It is recommended that you consult your nearest JVC dealer for replacing the video light.

SNAPSHOT Button

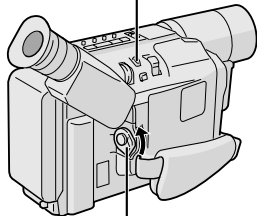

Power Switch

NOTES:

- After **SNAPSHOT** is pressed, there is a momentary camera shutter-type blackout together with the sound effect of a shutter closing, which is recorded together with the image.
- Snapshot is available during playback as well. However, the shutter sound is not heard.

NIGHT-SCOPE Button

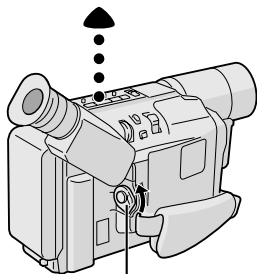
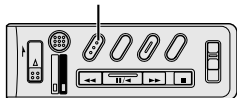

Power Switch

NOTES:

- During **Night-Scope**, the following functions or settings cannot be activated:
 - "Picture Stabilizer" (☞ pg. 16), "Program AE With Special Effects" (☞ pg. 20) and "Digital Effects" (☞ pg. 21).
 - "GAIN" or "S.LX" in **CAMERA MENU** (☞ pg. 23).
- **Night-Scope** does not work when **LIGHT OFF/AUTO/ON** is set to "AUTO" or "ON" (☞ pg. 17).
- During **Night-Scope**, it may be difficult to bring the camcorder into focus. To prevent this, use of a tripod is recommended.

Snapshot

Use your camcorder like a regular camera and take a snapshot, or several of them in succession.

1 Set the Power Switch to "A" or "M".

2 Press **SNAPSHOT**.

If you press during Record-Standby . . .

.... a still image will be recorded for approx. 6 seconds, then the camcorder re-enters the Record-Standby mode.

If you press during Recording . . .

.... a still image will be recorded for approx. 6 seconds, then the normal recording resumes.

Night-Scope

Makes dark subjects or areas even brighter than they would be under good natural lighting. Although the recorded image is not grainy, it may look as if it is strobing due to the slow shutter speed.

1 Set the Power Switch to "A" or "M".

2 Press **NIGHT-SCOPE** repeatedly until the desired mode's name and indication appear. They are displayed for approx. 2 seconds, then the name disappears so that only the indication remains. The mode is activated.

3 To cancel the effect, press **NIGHT-SCOPE** repeatedly until "OFF" appears. "OFF" is displayed for approx. 2 seconds.

**A NIGHT AUTO**

The shutter speed is automatically adjusted (maximum 1/5 sec.).

**1 NIGHT 10X***

The shutter speed is set to 1/5th of a second to provide 10 times the sensitivity.

**2 NIGHT 50X* (GR-SXM55 only)**

The shutter speed is set to 1 second to provide 50 times the sensitivity.

**2 NIGHT 25X* (GR-SXM607 only)**

The shutter speed is set to half of a second to provide 25 times the sensitivity.

*Appears when the Power Switch is set to "M".

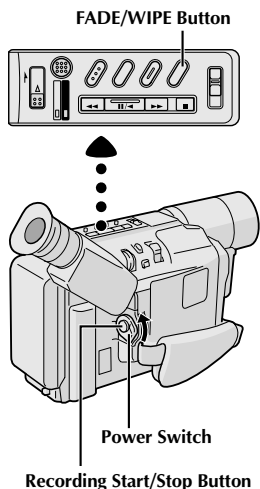

Fade/Wipe Effects

These effects let you make pro-style scene transitions. Fade- or wipe-in works at recording start, and fade- or wipe-out works at recording end.

- 1** Set the Power Switch to “**M**”.
- 2** Press **FADE/WIPE** repeatedly until the desired mode’s name and indication appear. They are displayed for approx. 2 seconds, then the name disappears so that only the indication remains. The effect is reserved.
- 3** Press the Recording Start/Stop Button to activate fade-in/out or wipe-in/out.
- 4** To cancel a fade or wipe, press **FADE/WIPE** repeatedly until “OFF” appears. “OFF” is displayed for approx. 2 seconds and the fade/wipe standby mode is cancelled.

Bk FADER

Fades in/out to a black screen.

MOSAIC (Fader)

Gradually turns/returns the picture into/from a mosaic pattern.

SHUTTER (Wipe)

A black screen moves in from the top and bottom, closing over the image like a shutter, or a new image pushes open the black screen vertically from the centre.

SLIDE (Wipe)

A black screen moves in from the left to gradually cover the image, or a new image moves in from right to left.

DOOR (Wipe)

Wipes in as the two halves of a black screen open to the left and right, revealing the scene, or wipes out and the black screen reappears from left and right to cover the scene.

CORNER (Wipe)

Wipes in on a black screen from the upper right to the lower left corner, revealing the scene, or wipes out from lower left to upper right, leaving a black screen.

WINDOW (Wipe)

Wipes in on a black screen from the centre of the screen towards the corners, revealing the scene, or wipe out from the corners to the centre, leaving a black screen.

NOTE:

Pressing and holding the Recording Start/Stop Button allows you to vary the length for the image during fade in/out or wipe in/out.

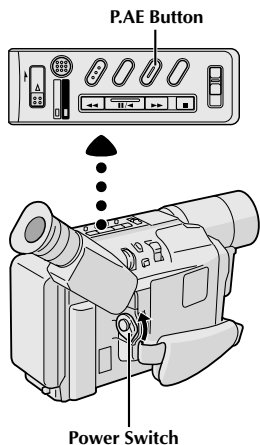

Program AE With Special Effects

- 1** Set the Power Switch to “**M**”.
- 2** Press **P.AE** repeatedly until the desired mode’s name and indication appear. They are displayed for approx. 2 seconds, then the name disappears so that only the indication remains. The mode is activated.
- 3** To cancel the effect, press **P.AE** repeatedly until “OFF” appears. “OFF” is displayed for approx. 2 seconds.

SPORTS

High shutter speed clearly captures fast-moving action.

ND : ND EFFECT

A black mist darkens the picture, as when an ND filter is used. Helps to counter the effects of glare on the subject.

FG : FOG

Makes the picture look misty white, as when an external fog filter is attached to the lens. Softens the image and gives it a “fantasy” look.

TWILIGHT

Dusk, twilight scenery, fireworks, etc., look more natural and dramatic. The following happens when Twilight mode is selected:

- Auto gain control is turned off.
- White Balance is set to “:FINE” (day mode), but can also be manually changed to another mode (☞ pg. 29).
- Auto Focus becomes available only in the range of 10 m to infinity. To focus when the subject-to-camera distance is less than 10 m, use manual focusing (☞ pg. 28).

S1/2000 (1/2000 sec. High Speed Shutter)

Captures faster action than Sports mode.

NOTES:

- Only one mode can be engaged at a time.
- The screen becomes slightly dark in the High Speed Shutter mode. Use in well-lit situations.
- In the “High Speed Shutter” or “Sports” modes, picture colour may be adversely affected if the subject is lit by alternating discharge-type light sources such as fluorescent or mercury-vapour lights.
- This function cannot be activated during Night-Scope (☞ pg. 18).
- The “FOG” mode cannot be used when the “VIDEO ECHO” mode (☞ pg. 21) is activated.

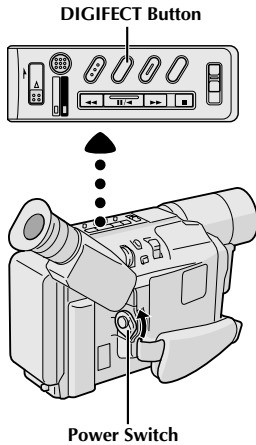

Digital Effects

- 1** Set the Power Switch to “”.
- 2** Press **DIGIFECT** repeatedly until the desired mode’s name and indication appear. They are displayed for approx. 2 seconds, then the name disappears so that only the indication remains. The mode is activated.
- 3** To cancel the effect, press **DIGIFECT** repeatedly until “OFF” appears. “OFF” is displayed for approx. 2 seconds.

SEPIA

Recorded scenes have a brownish tint like old photos. Combine this with the WIDE mode ( pg. 22, 23) for a classic look.

B/W MONOTONE

Like black and white films, your footage is shot in B/W. Combine this with the WIDE mode ( pg. 22, 23) for a classic look.

NEGA POSI

The colours of a picture are reversed.

MOSAIC

Turns recorded scenes into a mosaic pattern.

STRETCH

Doubles the width of the picture horizontally.

CLASSIC FILM

Makes your footage look like a classic movie by shooting in black and white, with a strobing effect, and black bars added at the top and bottom.



STROBE

Your recording looks like a series of consecutive snapshots.

VIDEO ECHO

Adds a “ghost” to the subject, giving your recording a “fantasy” feeling. Zoom magnification of over 10X is not available.

NOTES:

- Digital Effects can be changed during recording or during Record-Standby.
- Digital zoom ( pg. 16) cannot be used when the “VIDEO ECHO” mode is activated.
- This function cannot be activated during the “Night-Scope” ( pg. 18), “CLASSIC FILM”, “STROBE” and “VIDEO ECHO” mode.

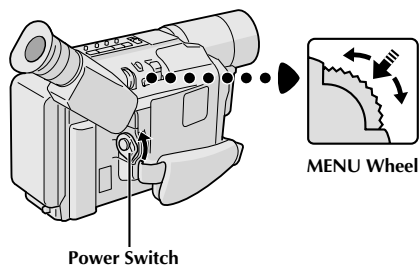

Display

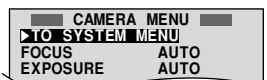

Menu Screen

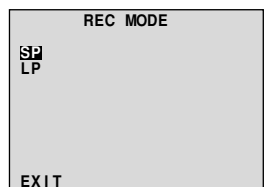
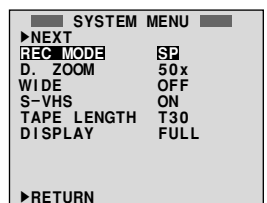
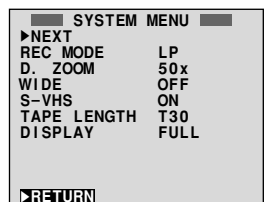
Setting Menu
(ex. REC MODE)

Normal Screen

Using Menus For Detailed Adjustment

This camcorder is equipped with an easy-to-use, on-screen menu system that simplifies many of the more detailed camcorder settings.

- 1 Set the Power Switch to "M".
- 2 Press MENU. The Menu Screen appears.
- 3 Rotate MENU to select the desired function.
 - To go from CAMERA MENU to SYSTEM MENU, rotate MENU to select "▶ TO SYSTEM MENU" and press it. SYSTEM MENU is composed of 2 pages. To go to the next page, rotate MENU to select "▶ NEXT" and press it.
 - To return to CAMERA MENU from page 2 of SYSTEM MENU, rotate MENU to select "▶ TO CAMERA MENU" and press it.
- 4 Press MENU to display the Setting Menu and rotate it to select the desired setting.

If you select "JLIP ID NO." . . .

.... Press MENU. The number blinks. Rotate MENU until the desired number appears, and press it. Then rotate MENU to "EXIT".
- 5 Press MENU. The Menu Screen reappears with the highlight bar on "▶ RETURN".
- 6 Press MENU. The normal screen reappears.

MENU SCREEN EXPLANATIONS

CAMERA MENU

FOCUS	Refer to "Focusing" (☞ pg. 28).	
EXPOSURE	Refer to "Exposure Control" (☞ pg. 27).	
M.W.B.	Refer to "White Balance Adjustment" and "Manual White Balance Operation" (☞ pg. 29).	
GAIN (GR-SXM607 only)	NORMAL	To record a subject in a dimly lit environment, when it is more convenient to shoot with a less coarse picture although the subject becomes slightly dark.
	OFF	Allows you to shoot dark scenes with no picture brightness adjustment.
S.LX (GR-SXM55 only)	MAX	To record a subject in a darkly lit environment, when it is more convenient to shoot the subject with a brighter image even if the picture becomes slightly coarse.
	NORMAL	To record a subject in a dimly lit environment, when it is more convenient to shoot with a less coarse picture although the subject becomes slightly dark.
	OFF	Allows you to shoot dark scenes with no picture brightness adjustment.
TITLE	Allows you to superimpose one of eight preset titles (☞ pg. 25).	
DATE/TIME DISP.	Makes the date/time settings appear in the camcorder or on a connected monitor (☞ pg. 25).	

SYSTEM MENU

This Menu Screen cannot be accessed while recording.

REC MODE	Allows you to set the recording mode (SP or LP) depending on your preference (☞ pg. 12).	
D. ZOOM	50X	Allows you to use the Digital Zoom. By digitally processing and magnifying images, zooming is possible from 16X (the optical zoom limit), to a maximum of 50X digital magnification.
	400X	Allows you to use the Digital Zoom. By digitally processing and magnifying images, zooming is possible from 16X (the optical zoom limit), to a maximum of 400X digital magnification.
	OFF	Digital Zoom is not available. Only optical zoom (maximum 16x magnification) can function. When set to "OFF" during Digital Zoom, zoom magnification changes to 16X.
WIDE	OFF	Does not display black bars.
	ON	Allows you to record black bars at the top and bottom of the screen to produce a cinema-like "wide-screen" effect. If a snapshot (☞ pg. 18) is taken while the camcorder is in the WIDE mode, the snapshot image is recorded without the black bars at the top and bottom of the screen.

 : Factory-preset

SYSTEM MENU (cont.)

S-VHS* (S-VHS ET*)	ON	Records in S-VHS on a VHS or S-VHS cassette (☞ pg. 10).
	OFF	Records in VHS on a VHS or S-VHS cassette (☞ pg. 10).
TAPE LENGTH	Allows you to set the tape length depending on the tape used (☞ pg. 12).	
DISPLAY	FULL	Make all of the indications appear on the LCD monitor/viewfinder during playback or recording.
	SIMPLE	Make the following indications disappear from the the LCD monitor/viewfinder during recording or playback: cassette warning, tape remaining time, battery pack remaining power indicator and tape length indicator (☞ pg. 52, 53)
REC TIME	Refer to "Animation" and "Time-Lapse" (☞ pg. 26).	
INT. TIME	Refer to "Time-Lapse" (☞ pg. 26).	
TELE MACRO	OFF	Usually the distance to a subject where the lens is in focus depends on the zoom magnification. Unless there is a distance of more than 1 m to the subject, the lens is out of focus at the maximum telephoto setting. When set to "ON", you can shoot a subject as large as possible at a distance of approx. 60 cm. • Depending on the zoom position, the lens may go out of focus.
	ON	
TITLE LANG.	Allows you to select the language (ENGLISH or FRENCH) of Instant Titles (☞ pg. 25).	
DATE/TIME	Allows you to set the current date and time (☞ pg. 9).	
JLIP ID NO.	This number is necessary when connecting the camcorder to a device such as a computer using the J terminal (JLIP). The numbers range from 01 to 99. Factory setting is 06.	
DEMO MODE	ON	Demonstrates certain functions automatically. When "DEMO MODE" is set to "ON" and the Menu Screen is closed, the demonstration starts. Operating the Power Zoom Lever during the demonstration stops the demonstration temporarily. If the Power Zoom Lever is not moved for more than 1 minute after that, the demonstration will resume. NOTE: <i>When a tape whose Erase Protection tab is in the position that allows recording is loaded in the camcorder, demonstration is not available.</i>
	OFF	Automatic demonstration will not take place.

*S-VHS ET is displayed when a VHS cassette is loaded, and S-VHS is displayed when an S-VHS cassette is loaded (☞ pg. 10). If a cassette is not loaded, "S-VHS" will be displayed in the Menu Screen. S-VHS ET is preset to "OFF".

 : Factory-preset

Date/Time Insert

Allows you to display the date and time in the camcorder or on a connected colour monitor, as well as to record them manually or automatically.

You should have already performed the Date/Time Setting procedure (☞ pg. 9).

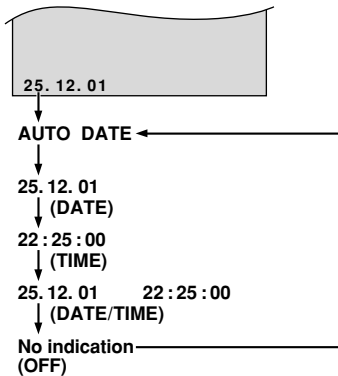
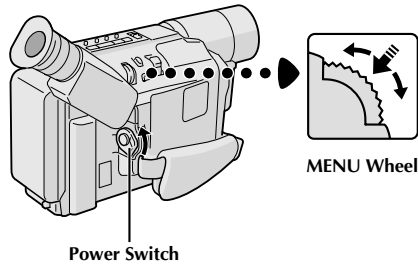

Instant Titles

The camcorder has eight preset titles in memory. You can superimpose one of them over the video image.

Instant Titles can be displayed not only in English but also in French. Change the setting in TITLE LANG. in SYSTEM MENU. (☞ pg. 24).

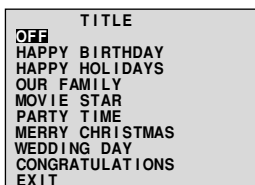

- 1 Set the Power Switch to "M".
- 2 Press **MENU**. The Menu Screen appears.
- 3 Rotate **MENU** to select "DATE/TIME DISP." and press it. The DATE/TIME DISP. Menu appears.
- 4 Rotate **MENU** to select the desired mode, then press it. The desired mode is activated.
- 5 The Menu Screen reappears with the highlight bar on "▶RETURN". Press **MENU** to close the Menu Screen.

NOTES:

DISPLAY

- The selected display can be recorded.
- If you do not want to record the display, select the OFF mode before shooting.

AUTO DATE

- Your camcorder automatically records the date for about 5 seconds after recording is initiated in the following situations:
 - After changing the date.
 - After loading a cassette.
 - After Auto Date Record mode is selected by rotating **MENU**.
- In this mode, the date is replaced after 5 seconds with "AUTO DATE" but this is not recorded.

- 1 Set the Power Switch to "M".
- 2 Press **MENU**. The Menu Screen appears.
- 3 Rotate **MENU** to select "TITLE" and press it. The TITLE Menu appears.
- 4 Rotate **MENU** to select the desired mode, then press it. The desired mode is activated.
- 5 The Menu Screen reappears with the highlight bar on "▶RETURN". Press **MENU** to close the Menu Screen.

NOTE:

The selected title will remain until OFF is selected in the TITLE Menu.

NOTE:

Before performing the following steps, make sure that:

- The Power Switch is set to "M".
- The camcorder is in the Record-Standby mode.
- The recording mode is set to "SP".

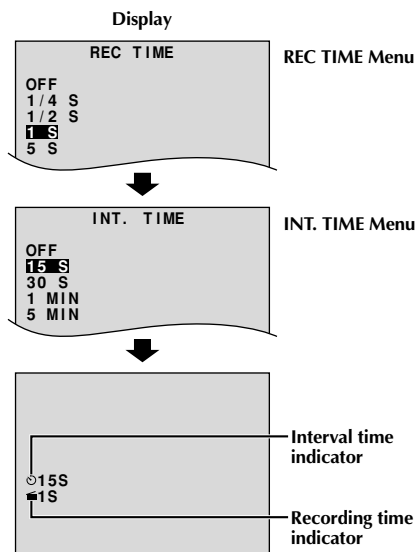
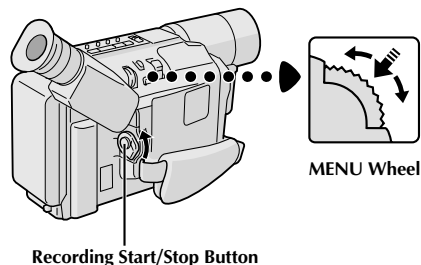
**Animation**

You can shoot a series of pictures, each slightly different, of the same object for a brief period of time.

- 1 Press **MENU**. The Menu Screen appears.
- 2 Rotate **MENU** to select "▶ TO SYSTEM MENU" and press it to display SYSTEM MENU. Rotate **MENU** to select "▶ NEXT" and press it to display the next page. Then, rotate **MENU** to select "REC TIME" and press it. The REC TIME Menu appears. Rotate **MENU** to select the desired recording time, then press it.
- 3 The Menu Screen reappears with the highlight bar on "▶ RETURN". Press **MENU** again to close the Menu Screen.
- 4 Press the Recording Start/Stop Button after focusing on the subject. The recording stops automatically after the selected period of time.
 - Repeat step 4 for the desired number of pictures.
- 5 To release the Animation mode, set "REC TIME" in the Menu screen to "OFF".

Time-Lapse

You can record sequentially at preset time spans. Leaving the camcorder aimed at a specific subject, you can record subtle changes over an extended period of time.

- 1 Set "REC TIME" (☞ step 1 and 2 of "Animation" above).
- 2 Rotate **MENU** to select "INT. TIME" and press it. The INT. TIME Menu appears. Rotate **MENU** to select the desired interval time, then press it. The Menu Screen reappears with the highlight bar on "▶ RETURN". Press **MENU** again to close the Menu Screen.
- 3 Press the Recording Start/Stop Button. Recording and intervals alternate automatically.
- 4 To release the Time-Lapse mode, when "REC" is not displayed, press the Recording Start/Stop Button to display "≡ PAUSE ≡", then set "REC TIME" and "INT. TIME" in the Menu Screen to "OFF".

NOTES (for Animation and Time-Lapse):

- For best results, make sure the camcorder is secured when shooting in Animation or Time-Lapse mode.
- Fade- or wipe-in/out cannot be performed during Animation or Time-Lapse shooting.
- Before performing other operations following Animation or Time-Lapse recording, make sure the Animation or Time-Lapse mode is deactivated.
- Animation and Time-Lapse are canceled when the power is shut off or when the cassette is ejected.

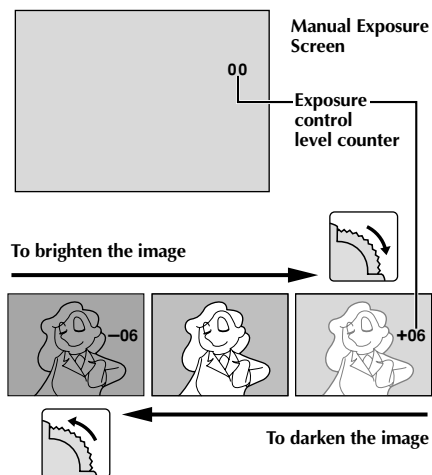
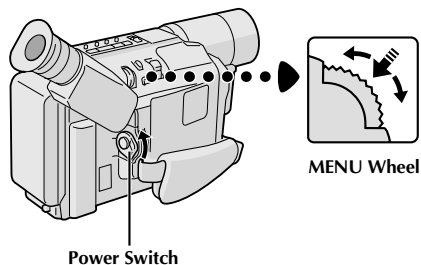

Exposure Control

This feature automatically adjusts the iris for the best available picture quality, but you can override it and make the adjustment manually. Manual exposure adjustment is recommended in the following situations:

- When shooting using reverse lighting or when the background is too bright.
- When shooting on a reflective natural background such as at the beach or when skiing.
- When the background is overly dark or the subject light.

- 1 Set the Power Switch to "M".
- 2 Press **MENU**. The Menu Screen appears.
- 3 Rotate **MENU** to select "EXPOSURE" and press it. The EXPOSURE Menu appears.
- 4 Rotate **MENU** to select "MANU", then press it. The Menu Screen disappears and "00" (exposure control level counter) appears.
- 5 To brighten the image, rotate **MENU** downward. The exposure control level counter increases (maximum +06).
To darken the image, rotate **MENU** upward. The exposure control level counter decreases (maximum -06).
- 6 Press **MENU**. The setting is complete. The Menu Screen reappears with the highlight bar on "▶RETURN".
- 7 Press **MENU**. The Menu Screen disappears and the exposure control level counter reappears to indicate the exposure is adjusted.

NOTES:

- To return to the factory setting, select "AUTO" in step 4.
- To re-adjust exposure, repeat the procedure from step 2.

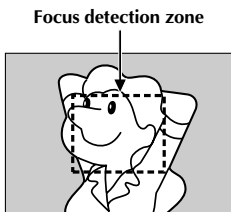
**NOTES:**

- If the lens is smeared or blurred, accurate focusing is not possible. Keep the lens clean, wiping with a piece of soft cloth if it gets dirty. When condensation occurs, wipe with a soft cloth or wait for it to dry naturally.
- When shooting a subject close to the lens, zoom out first (☞ pg. 16). If zoomed in in the auto focus mode, the camcorder could automatically zoom out depending on the distance between the camcorder and the subject. This does not occur with "TELE MACRO" (☞ pg. 24).

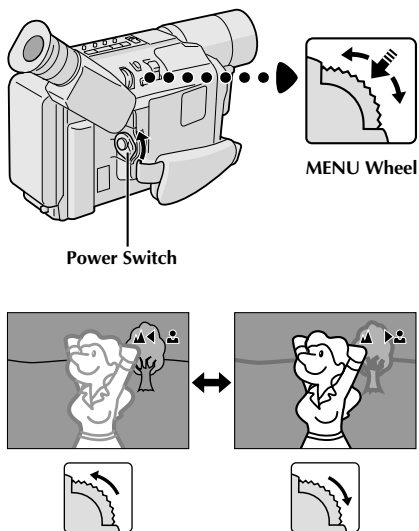
**Focusing****AUTO FOCUS**

The camcorder's Full Range AF system offers continuous shooting ability from close-up to infinity. However, correct focus may not be obtainable in the situations listed below (in these cases use manual focusing):

- When two subjects overlap in the same scene.
- When illumination is low.*
- When the subject has no contrast (difference in brightness and darkness), such as a flat, one-colour wall, or a clear, blue sky.*
- When a dark object is barely visible in the viewfinder.*
- When the scene contains minute patterns or identical patterns that are regularly repeated.
- When the scene is affected by sunbeams or light reflecting off the surface of a body of water.
- When shooting a scene with a high-contrast background.

* The low-contrast warning "▲▲" appears.

MANUAL FOCUS

Make the necessary viewfinder adjustments to use the viewfinder (☞ pg. 8).

- 1 Set the Power Switch to "M".
- 2 Press MENU. The Menu Screen appears.
- 3 Rotate MENU to select "FOCUS" and press it. The FOCUS Menu appears.
- 4 Rotate MENU to select "MANU", then press it. The Menu Screen disappears and "▲" and "▲" appear. The focus is locked at this point.
- 5 To focus on a farther subject, rotate MENU upward. "◀" appears and blinks.
To focus on a nearer subject, rotate MENU downward. "▶" appears and blinks.
- 6 Press MENU. The setting is complete. The Menu Screen reappears with the highlight bar on "▶RETURN".
- 7 Press MENU. The Menu Screen disappears and "▲▲" reappears to indicate the focus is locked.

NOTES:

- To return to Auto Focus, select "AUTO" in step 4.
- To re-adjust Manual Focus, repeat the procedure from step 2.
- Be sure to focus the lens in the maximum telephoto position when you use the Manual Focus mode. If you focus in on a certain subject in the wide-angle position, sharply focused images cannot be obtained when zoomed in because the depth-of-field is reduced at longer focal lengths.
- When the focus level cannot be adjusted any farther or closer, "▲" or "▲" will blink.

White Balance Adjustment

A term that refers to the correctness of colour reproduction under various lighting. If the white balance is correct, all other colors will be accurately reproduced.

The white balance is usually adjusted automatically. However, more advanced camcorder operators control this function manually to achieve a more professional colour/tint reproduction.

- 1** Set the Power Switch to "M".
- 2** Press **MENU**. The Menu Screen appears.
- 3** Rotate **MENU** to select "M.W.B.", then press it. The M.W.B. Menu appears.
- 4** Rotate **MENU** to select the desired setting.
 - "**AUTO**"
White balance is adjusted automatically (factory preset).
 - "☀️ : **FINE**"
Outdoors on a sunny day.
 - "☁️ : **CLOUD**"
Outdoors on a cloudy day.
 - "💡 : **HALOGEN**"
A video light or similar type of lighting is used.
 - "**MWB**"
White balance is set manually.
- 5** Press **MENU**. The Menu Screen reappears with the highlight bar on "▶ RETURN". Press **MENU** again to close the Menu Screen.

To Return To Automatic White Balance . . .

.... select "AUTO" in step 4. Or set the Power Switch to "A".

NOTE:

White balance cannot be used when the "SEPIA" or "MONOTONE" mode (☞ pg. 21) is activated.

Manual White Balance Operation

Perform Manual White Balance when shooting under various types of lighting.

- 1** Follow steps 1 through 4 of the white balance adjustment, and select "MWB".
- 2** Hold a sheet of plain white paper in front of the subject. Adjust zoom or position yourself so that the white paper fills the screen.
- 3** Press **MENU** until "MWB" begins blinking. When the setting is completed, "MWB" stops blinking, and the Menu Screen reappears with the highlight bar on "▶ RETURN".
- 4** Press **MENU** again to close the Menu Screen.

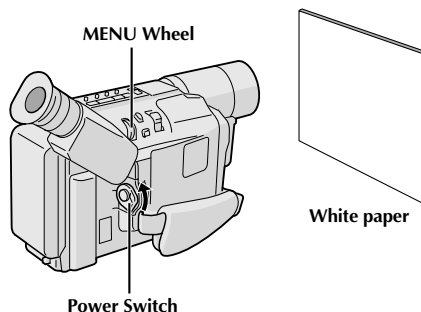

To Change The Tint For Recording . . .

.... in step 2, substitute coloured paper for white. The white balance is adjusted based on the colour, changing the tint. Red paper = deeper green; blue paper = orange; yellow paper = deeper purple.

NOTES:

- In step 2, it may be difficult to focus on the white paper. In such a case, adjust focus manually (☞ pg. 28).
- A subject can be shot under various types of lighting conditions indoors (natural, flourescent, candlelight, etc.). Because the colour temperature is different depending on the light source, the subject tint will differ depending on the white balance settings. Use this function for a more natural result.
- Once you adjust white balance manually, the setting is retained even if the power is turned off or the battery removed.

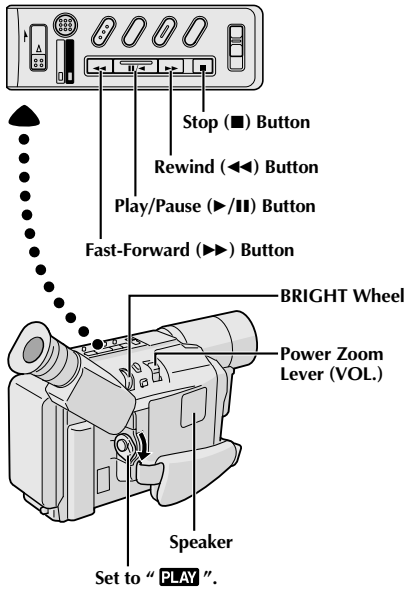

1 Load a tape (☞ pg. 13).

2 Set the Power Switch to "PLAY".
To start playback, press ▶/||.
• To stop playback, press ■.
• Press ◀◀ to rewind, or ▶▶ to fast-forward the tape during Stop mode.

NOTES:

- The camcorder shuts off automatically after about 5 minutes in Stop mode. To turn on again, set the Power Switch to "OFF", then to "PLAY".
- When the Power Switch is set to "PLAY" and the LCD monitor is opened at an angle of 60 degrees or more, the LCD monitor switches on and the viewfinder switches off automatically to save power.
- The playback picture can be viewed in the viewfinder (with the LCD monitor shut), on the LCD monitor or on a connected TV (☞ pg. 32, 33).
- You can also view the playback picture on the LCD monitor with it flipped over and retracted.
- If a blank portion on the tape is played back, the screen may become black. This is not a malfunction.

LCD Monitor Brightness Adjustment: Rotate **BRIGHT** towards "+" to brighten, or towards "-" to darken.

- The Bright Level Indicator is displayed under the Date/Time Display when you play back images recorded in Wide Mode (☞ pg. 23).

Speaker Volume Control: Slide the Power Zoom Lever (VOL.) towards "+" to turn up the volume, or towards "-" to turn down the volume.

- The Speaker Volume Indicator is displayed under the Date/Time Display when you play back images recorded in Wide Mode (☞ pg. 23).

Still Playback: Pauses during playback.

- 1) Press ▶/|| during playback.
 - 2) To resume normal playback, press ▶/|| again.
- Noise bars will appear and the picture will become monochrome during Still Playback.
 - If TBC (☞ pg. 31) is engaged, noise bars will not appear. This mode is called Fine Still.

Shuttle Search: Allows high-speed search in either direction.

- 1) Press ▶▶ for forward or ◀◀ for reverse search during playback.
 - 2) To resume normal playback, press ▶/||.
- During playback, press and hold ◀◀ or ▶▶. The search continues as long as you hold the button. Once you release it, normal playback resumes.
 - Noise bars appear and pictures may become monochrome or darken during Shuttle Search. This is normal.

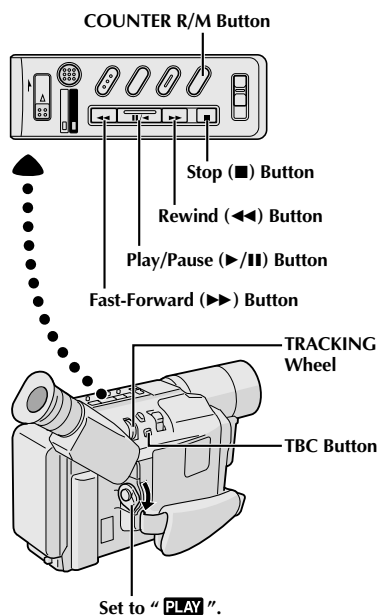

Tracking: Eliminates noise bars that appear on-screen during playback. Factory-preset is Auto Tracking. To activate Manual Tracking:

- 1) Press **TRACKING** for approx. 2 seconds. "MT" appears.
- 2) Rotate **TRACKING** so that the noise bars disappear.
 - To return to Auto Tracking, press **TRACKING** for approx. 2 seconds or set the Power Switch to "OFF" and then "**PLAY**" again. "AT" blinks. When Auto Tracking finishes, the indication disappears.
 - When noise bars appear during playback, the camcorder enters the Auto Tracking mode and "AT" is displayed.
 - Manual Tracking may not work with tapes recorded on other VCRs or camcorders.

TBC (Time Base Corrector): Removes jitter from fluctuating video signals to deliver a stable picture even with old tapes. Factory-preset: TBC is engaged. To activate/release the TBC mode, press **TBC** during playback for more than 1 second. When the TBC mode is activated, "TBC" is displayed.

Counter Memory Function: Makes it easier to locate a specific tape segment.

- 1) Press **COUNTER R/M** and hold for more than 1 second. The counter resets to "0:00:00".
- 2) Press **COUNTER R/M** for less than 1 second. "M" appears.
- 3) After recording or playback, press **■**, then **◀◀**. The tape automatically stops at or close to 0:00:00.
- 4) Press **▶/||** to start playback.
 - The counter memory functions in the Fast-Forward and Rewind modes.
 - To disable the Counter Memory Function, press **COUNTER R/M** for less than 1 second so that "M" disappears.

Playback Special Effects (CLASSIC FILM, MONOTONE, SEPIA, STROBE and VIDEO ECHO,  pg. 21): Allows you to add creative effects to the playback image.

- 1) Activate the TBC mode and Auto Tracking.
- 2) Press **DIGIFECT** repeatedly until the desired mode's name and indication appear. They are displayed for approx. 2 seconds, then the name disappears so that only the indication remains. The mode is activated.
- 3) To cancel the effect, select "OFF" in step 2.
 - Playback Special Effects do not work during shuttle search.
 - The selected effect mode cannot be changed during still playback.

Use the provided A/V cable and S-Video cable.

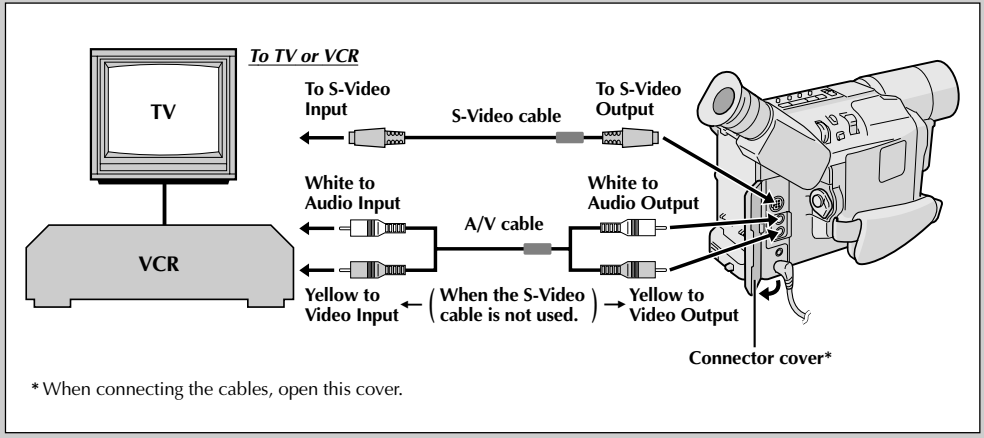

If your TV/VCR has a 21-pin connector

Use the provided Cable Adapter.

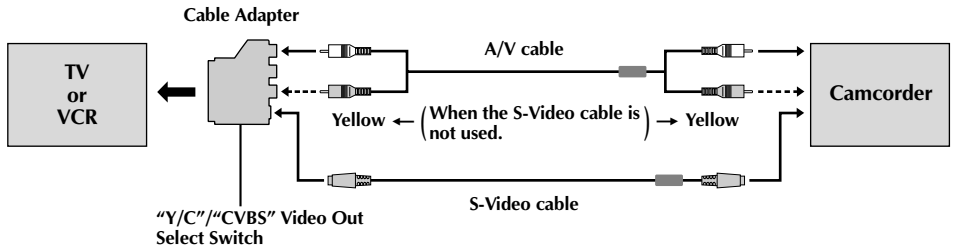

NOTES:

Set the video out select switch of the cable adapter as required:

Y/C : When connecting to a TV or VCR which accepts Y/C signals and uses an S-Video cable.

CVBS : When connecting to a TV or VCR which does not accept Y/C signals and uses an A/V cable.

Basic Connections

- 1** Make sure all units are turned off.

- 2** Connect the camcorder to a TV or VCR as shown in the illustration (☞ pg. 32).
If using a VCR . . . go to step 3.
If not . . . go to step 4.

- 3** Connect the VCR output to the TV input, referring to your VCR's instruction manual.

- 4** Turn on the camcorder, the VCR and the TV.

- 5** Set the VCR to its AUX input mode, and set the TV to its VIDEO mode.

NOTES:

- *It is recommended to use the AC Adapter as the power supply instead of the battery pack (☞ pg. 7).*
- *If your VCR has an S-Video input connector, connect the camcorder and the VCR using the provided S-Video cable. This can improve the dubbed picture quality.*
- *To monitor the picture and sound from the camcorder without inserting a tape, set the camcorder's Power Switch to "A" or "M", then set your TV to the appropriate input mode.*
- *Make sure you adjust the TV sound volume to its minimum level to avoid a sudden burst of sound when the camcorder is turned on.*
- *If you have a TV or speakers that are not specially shielded, do not place the speakers adjacent to the TV as interference will occur in the camcorder playback picture.*

Tape Dubbing

- 1** Following the illustration on pg. 32, connect the camcorder and the VCR.

- 2** Set the camcorder's Power Switch to "PLAY", turn on the VCR's power, and insert the appropriate cassettes in the camcorder and the VCR.

- 3** Engage the VCR's AUX and Record-Pause modes.

- 4** Engage the camcorder's Play mode to find a spot just before the edit-in point. Once it is reached, press ►/|| on the camcorder.

- 5** Press ►/|| on the camcorder and engage the VCR's Record mode.

- 6** Engage the VCR's Record-Pause mode and press ►/|| on the camcorder.

- 7** Repeat steps 4 through 6 for additional editing, then stop the VCR and camcorder when finished.

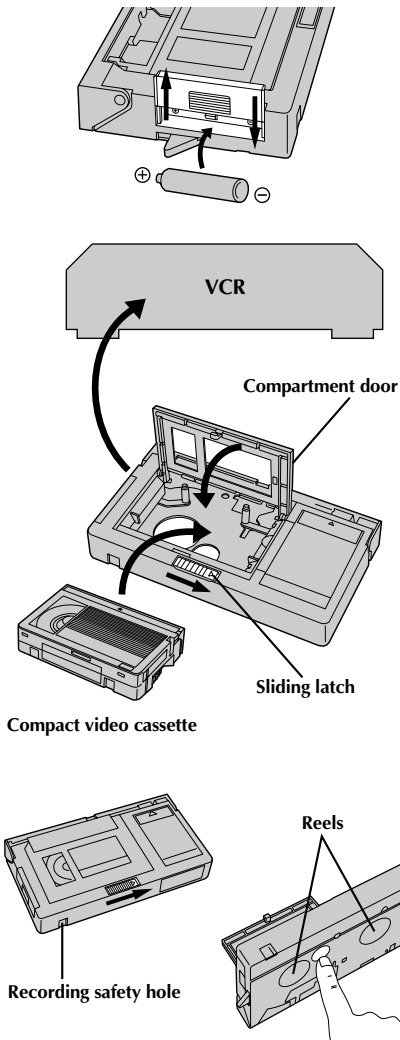

Cassette Adapter (optional)

Use this to play back an S-VHS-C/VHS-C video cassette recorded with this camcorder on a VHS VCR. It is fully compatible with any S-VHS/VHS video cassette recorder. The C-P7U (optional) adapter is battery powered and automatically performs tape loading and unloading.

- 1** Slide the battery cover up to remove it, install one "AA (R6)" size battery as shown, then reattach the cover.
- 2** Slide the latch to open the adapter compartment door, then insert the cassette and close the compartment door.
- 3** Load the cassette adapter into the VCR and play the tape back as you would any other.
- 4** Slide the latch and the compartment door opens automatically. This may take around 10 seconds. Do not attempt to force the adapter open. Then, insert your finger in the hole on the underside of the adapter as shown in the illustration at left, and push up and remove the cassette.

NOTES:

- During tape loading and unloading, do not touch the reels for safety and tape protection.
- Tapes recorded in S-VHS or S-VHS ET mode cannot be played back on a regular VHS VCR. Playback is possible with a VCR equipped with the S-VHS function.
- During special-effect playback (slow motion, still frame, etc.), the picture may vibrate or noise bars may appear on the screen.
- To record on a VCR using a compact cassette and the adapter, cover the adapter's recording safety hole with adhesive tape.

The Full-Function Remote Control Unit can operate this camcorder from a distance as well as the basic operations (Playback, Stop, Pause, Fast-Forward and Rewind) of your VCR.

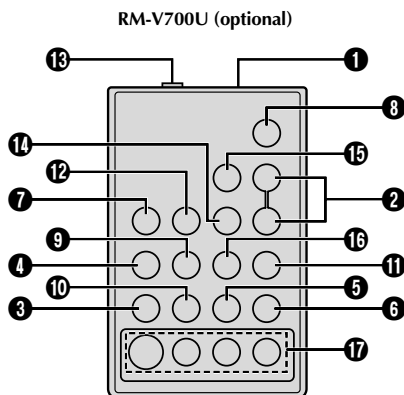
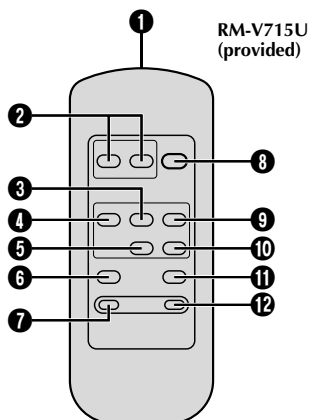

Buttons	Functions	
	With the camcorder's Power Switch set to "A" or "M".	With the camcorder's Power Switch set to "PLAY".
1 Infrared beam transmitting window	Transmits the beam signal.	
2 ZOOM (T/W) Buttons	Zoom in/out (☞ pg. 16)	Zoom in/out (☞ pg. 37)
3 PLAY Button	—	Playback start (☞ pg. 30)
4 REW Button	Retake (rewind), Quick Review (☞ pg. 17)	Rewind, Reverse Shuttle Search (☞ pg. 30)
5 STOP Button	—	Stop (☞ pg. 30)
6 INSERT Button	—	Insert Editing (☞ pg. 38)
7 REC TIME Button ANIM. Button	Animation, Time-Lapse (☞ pg. 37)	—
8 START/STOP Button	Functions the same as the Recording Start/Stop Button on the camcorder.	
9 FF Button	Retake (forward) (☞ pg. 17)	Fast-Forward, Forward Shuttle Search (☞ pg. 30)
10 PAUSE Button	—	Pause (☞ pg. 30)
11 A.DUB Button	—	Audio dubbing (☞ pg. 39)
12 INT. TIME Button SELF TIMER Button*	Time-Lapse (☞ pg. 37)	—
13 PAUSE IN Connector	—	☞ pg. 41
14 MBR SET Button	—	☞ pg. 40
15 VISS Button	Ineffective	
16 VCR CTL Button	—	☞ pg. 40
17 R.A.EDIT Buttons	—	☞ pg. 42

*This function is unavailable with this camcorder.

13 – **17**: RM-V700U only

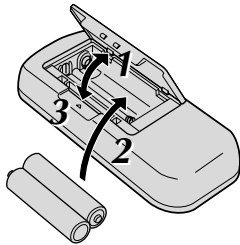

Installing The Batteries (RM-V715U, provided)

The remote control uses two "AAA (R03)" size batteries. See "General Battery Precautions" (pg. 45).

- 1** Open the battery compartment cover as illustrated.
- 2** Insert two "AAA (R03)" size batteries in the correct direction.
- 3** Replace the battery compartment cover.

A

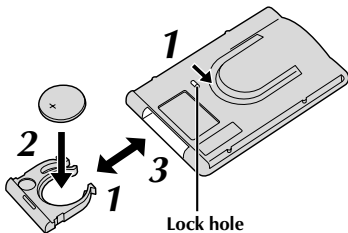

B

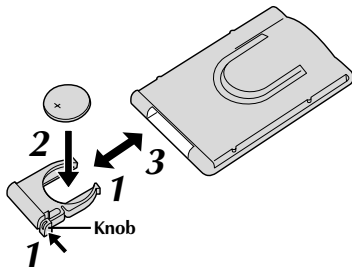

Installing The Battery (RM-V700U, optional)

The remote control uses one lithium battery (CR2025).

- 1** **A** : Pull out the battery holder while sliding the lock hole.
B : Pinch the release tab and pull out the battery holder.
- 2** Insert the battery in the holder, and be sure to have the "+" mark visible.
- 3** Slide the holder back in until you hear a click.
• Read the cautions in the instructions provided with the RM-V700U.

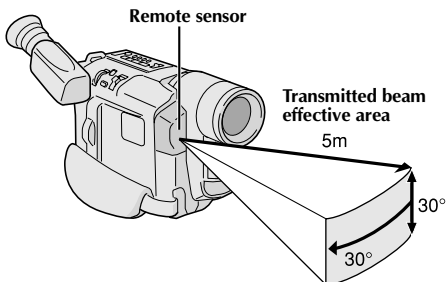

When using the remote control, be sure to point it at the remote sensor. The illustration shows the approximate transmitted beam effective area for indoor use.

The transmitted beam may not be effective or may cause incorrect operation outdoors or when the remote sensor is directly exposed to sunlight or powerful lighting.

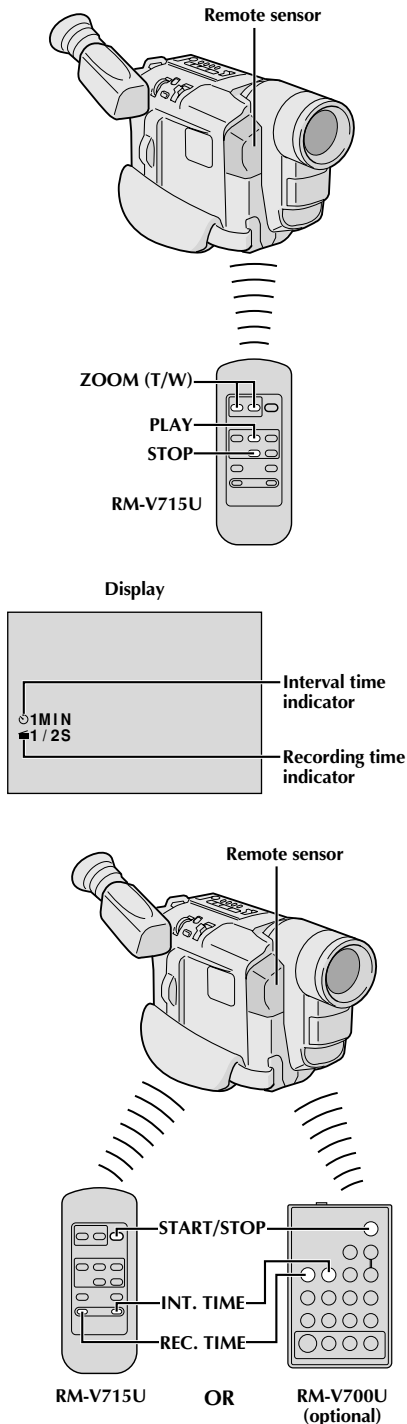

Playback Zoom

To magnify the recorded image up to 10X at any time during playback.

NOTES:

- Use the RM-V715U remote control unit to perform this procedure.
- Make sure that the TBC mode is activated (☑ pg. 31).

- 1) Press **PLAY** to find the scene of interest.
- 2) Press the **ZOOM** Buttons (**T/W**) on the remote control. Make sure the remote control is pointed at the camcorder's remote sensor. Pressing **T** zooms in.

To End Zoom . . .

.... press and hold **W** until magnification returns to normal. Or, press **STOP** and then press **PLAY**.

NOTES:

- Zoom can also be used during still playback.
- Due to digital image processing, the quality of the image may suffer.
- After zooming in on a still video image, when normal playback is started, the zoomed-in effect is momentarily cancelled but then resumes, returning magnification to the previously set level.

Animation and Time-Lapse

The remote control lets you set/release Interval Time and Recording Time without using the Menu Screen.

Animation

1) Set

Instead of performing steps **1** and **2** on pg. 26 ("Animation"), press **REC TIME** on the remote control. Each time **REC TIME** is pressed, the Recording Time indicator appears, changing in the following order: 1/4S, 1/2S, 1S, 5S and no indication (off).

2) Release

Instead of using the Menu in step **5** on pg. 26, press **REC TIME** on the remote control until the Recording Time indicator disappears.

Time-Lapse

1) Set

Instead of performing steps **1** and **2** on pg. 26 ("Time-Lapse"), press **REC TIME** and **INT. TIME** on the remote control. Each time **REC TIME** is pressed, the Recording Time indicator appears, changing in the following order: 1/4S, 1/2S, 1S, 5S and no indication (off). Each time **INT. TIME** is pressed, the Interval Time indicator appears, changing in the following order: 15S, 30S, 1MIN, 5MIN and no indication (off).

2) Release

Instead of using the Menu in step **4** on pg. 26 ("Time-Lapse"), press **REC TIME** and **INT. TIME** on the remote control until the indicators disappear.

NOTE:

Also refer to pg. 26.

COUNTER R/M Button

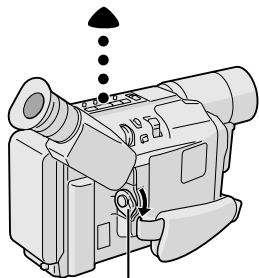
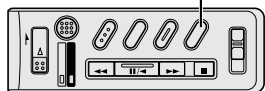

Power Switch

Display

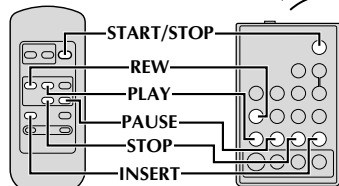
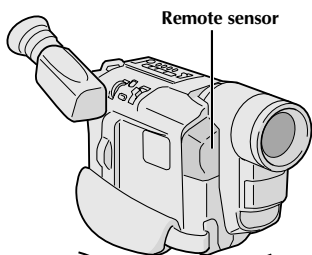
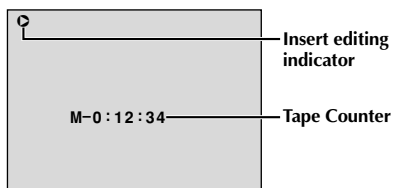

RM-V715U

OR

RM-V700U
(optional)

Insert Editing

You can record a new scene onto a previously recorded tape, replacing a section of the original recording with minimal picture distortion at the in- and out-points. The original audio remains unchanged.

NOTE:

Use the remote control unit to perform this procedure.

- 1** Set the Power Switch to "PLAY".
- 2** Play back the tape, locate the Edit-Out point and press PAUSE.
- 3** Press and hold **COUNTER R/M** on the camcorder for more than 1 second to reset the tape counter, then press it again for less than 1 second so that "M" appears.
- 4** Press **REW** to go a little beyond the beginning of the scene you want to replace, press **PLAY** to view the recorded tape, and press **PAUSE** exactly at the Edit-In point where the new scene should start.
- 5** Press and hold **INSERT**, and without releasing **INSERT**, press and release **PAUSE**. The Insert Editing indicator appears and the Insert Editing mode is engaged. When the scene the camcorder is aimed at appears on the screen, go to the next step.
- 6** To begin Insert Editing, press **START/STOP**. When the counter reaches "0:00:00", editing stops automatically and the camcorder enters the Insert-Pause mode.
- 7** To end Insert Editing, press **STOP**.

NOTES:

- During Insert Editing, the original audio will be heard from the speaker.
- After step 5, Retake (☐ pg. 17) can be performed.
- The tape may stop slightly before or after the designated end point, and noise bars may appear. Neither indicates a defect in the unit.
- Only the video signal is recorded in the Insert Editing mode.

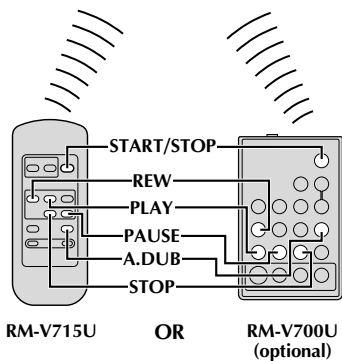
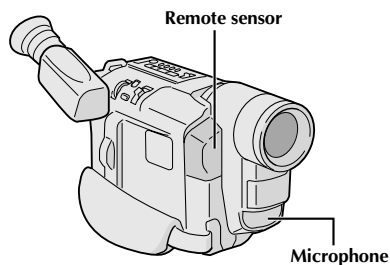
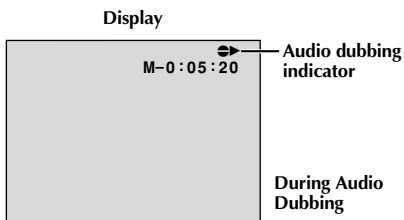

Audio Dubbing

You can record a new soundtrack on a prerecorded tape. The existing original sound is erased and replaced by the sound from the built-in microphone.

Perform steps 1, 2 and 3 of the Insert Editing procedure (pg. 38) before continuing.

NOTE:

Use the remote control unit to perform the following procedures.

- 1** Press **REW** to go a little beyond the beginning of the scene onto which you want to dub the new audio, press **PLAY** to view the recorded tape, then press **PAUSE** at exactly the point where dubbing should start.
- 2** Press and hold **A. DUB**, and without releasing **A. DUB**, press and release **PAUSE**. The Audio Dub-Standby mode is engaged.
- 3** To begin Audio Dubbing, press **PLAY**. When the counter reaches "0:00:00", Audio Dubbing stops automatically and the camcorder enters the Audio Dub-Standby mode.
- 4** To end Audio Dubbing, press **STOP**.

NOTES:

- Do not press **FF** or **REW** during Audio Dub-Standby, or the edit points will not be accurate.
- If the microphone is too close to the TV, or if the TV's volume is too high, whistling or howling may occur.

NOTES

(for Insert Editing and Audio Dubbing):

- Insert Editing and Audio Dubbing may not work correctly if the tape contains blank segments, or if the recording speed was changed during the original recording.
- To edit/dub onto a tape, make sure the Erase Protection tab is in the position that allows recording. If not, slide the tab. Some cassettes have removable tabs. If the tab has been removed, cover the hole with adhesive tape.
- Do not press **STOP** during Insert Editing or Audio Dubbing, or the edit points will not be accurate.
- During Insert Editing and Audio Dubbing, when Insert-Pause or Audio Dub-Standby is engaged, the counter may go slightly past "0:00:00". Recording, however, stops at exactly 0:00:00.

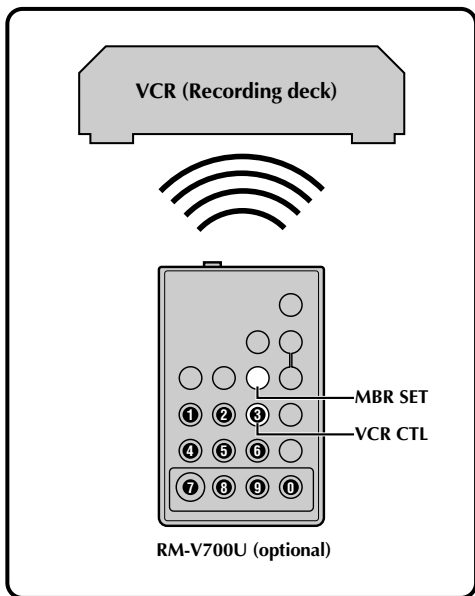

VCR CODE LIST

VCR BRAND NAME	BUTTONS (A) (B)	VCR BRAND NAME	BUTTONS (A) (B)
AKAI	6 2 6 4 7 7	PHILIPS	1 9 9 5 1 1 9 4 9 1 9 6 1 2 3 3 7 2
BLAUPUNKT	1 3	SANYO	3 6 3 5
FERGUSON	9 7 9 8 3 2	SELECO, REX	9 1 9 6
GRUNDIG	1 4 3 4	SHARP	1 5 1 0
HITACHI	6 6 6 3	SONY	6 5 6 0 3 9 3 1
JVC A B C	9 1 9 6 9 3	THOMSON, TELEFUNKEN, SABA, NORDMENDE	9 1 9 6 9 7 3 2
MITSUBISHI	6 7 6 8	TOSHIBA	6 9 6 1
NEC	3 7 3 8		
PANASONIC	1 3 1 7 1 1 9 4 1 8		

Random Assemble Editing [R.A.Edit]

Create edited videos easily using your camcorder as the source player. You can select up to 8 "cuts" for automatic editing, in any order you like. R.A.Edit is more easily performed when the RM-V700U MBR (Multi-Brand Remote, see pg. 35) is set to operate with your brand of VCR (see VCR CODE LIST), but can also be performed by operating the VCR manually.

Before operation, make sure the lithium battery is installed in the remote control RM-V700U (see pg. 36).

SET REMOTE/VCR CODE

1 Turn off the power to the VCR and point the remote towards the VCR's infrared sensor. Then, referring to the VCR CODE LIST on the left, press and hold **MBR SET**, and press button (A) and then (B).

- The code is automatically set once you release **MBR SET**, and the VCR's power comes on.

2 Make sure the VCR's power is on. Then, while holding **VCR CTL**, press the button on the remote for the desired function. The functions the remote can control are PLAY, STOP, PAUSE, FF, REW and VCR REC STBY (you do not need to press **VCR CTL** for this one).

You are now ready to try Random Assemble Editing.

IMPORTANT

Although the MBR is compatible with JVC VCRs and those of many other makers, it may not work with yours or may offer limited functions.

NOTES:

- If the VCR's power does not come on in step 1, try another code from the VCR CODE LIST.
- Some brands of VCR do not come on automatically. In this case, turn the power on manually and try step 2.
- If the remote control is not able to control the VCR, use the controls on the VCR.
- When the remote control's battery runs out, the VCR brand you have set will be erased. In that case, replace the old battery with a new one and reset the VCR brand.

MAKE CONNECTIONS

1

A JVC VCR EQUIPPED WITH REMOTE PAUSE TERMINAL

Connect the editing cable to the Remote PAUSE terminal.

B JVC VCR NOT EQUIPPED WITH REMOTE PAUSE TERMINAL BUT EQUIPPED WITH R.A. EDIT CONNECTOR

Connect the editing cable to the R.A.EDIT connector.

C VCR OTHER THAN TYPE **A** OR **B**

Connect the editing cable to the RM-V700U's PAUSE-IN connector.

2

Insert a recorded tape into the camcorder and set the Power Switch to "PLAY".

3

Turn the VCR power on, insert a recordable tape and engage the AUX mode (refer to the VCR's instructions).

NOTES:

- If your VCR has an S-Video input connector or a SCART connector compatible with Y/C signals, connect the camcorder and the VCR using the provided S-Video cable. This can improve the dubbed picture quality.
- If you use the cable adapter, set the "Y/C"/"CVBS" video out select switch as required.

Y/C : When connecting to a VCR which accepts Y/C signals and uses an S-Video cable.

CVBS : When connecting to a VCR which does not accept Y/C signals and uses an A/V cable.

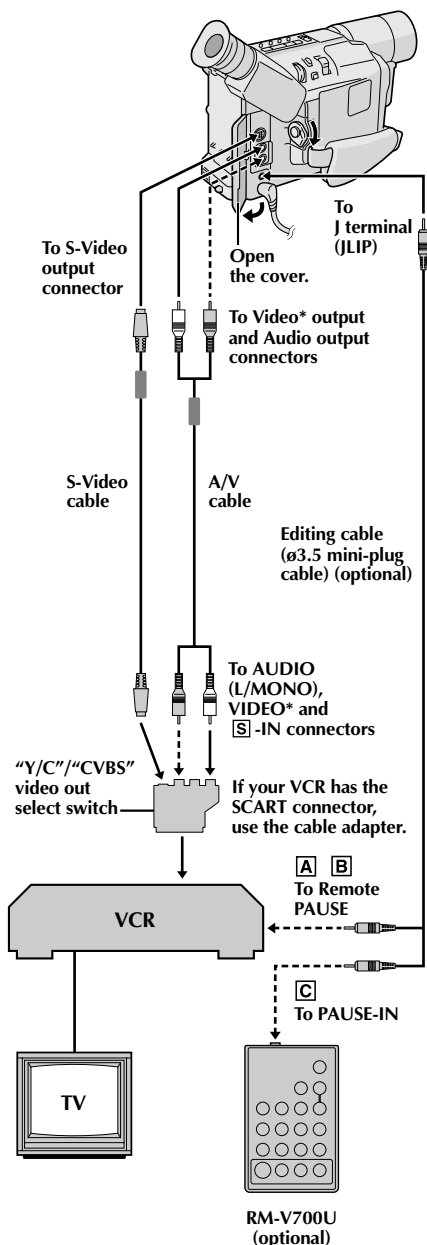

* Connect when an S-Video cable is not used.

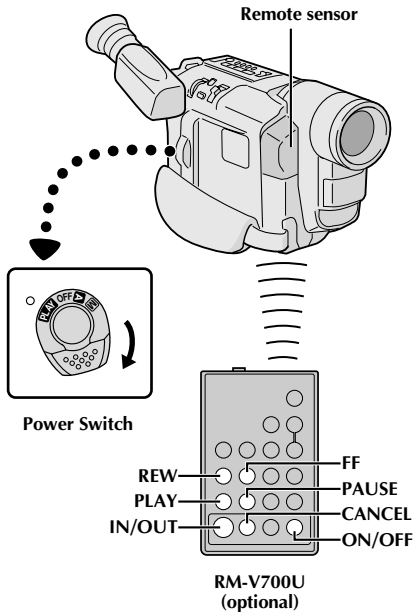

	IN	OUT
1	0:00:25	---:--:--
2		
3		
4		
5		
6		
7		
8		
COUNTER	0:00:25	
TOTAL	0:00:00	

	IN	OUT
1	0:00:25	0:01:05
2	0:03:18	0:03:31
3	0:02:33	0:02:53
4	0:04:11	---:--:--
5		
6		
7		
8		
COUNTER	0:04:11	
TOTAL	0:01:13	

SELECT SCENES

- 4** Point the remote control at the camcorder's remote sensor. Press **PLAY**, then press **ON/OFF** on the remote control. The R.A. Edit counter display appears.
- 5** Press **REW** or **FF** to locate the beginning of the scene you want, then press **IN/OUT** to register that point. The data appears under "IN" on the display.
- 6** Press **REW** or **FF** to locate the end of the scene and press **IN/OUT** to register it.
 - The data appears under "OUT" on the display.
 - The total time of the registered scene(s) is displayed at the bottom of the screen.
- 7** Repeat steps 5 and 6 for each additional scene (as many as 8).
- 8** To make corrections, press **CANCEL** during steps 5 and 6 to erase the most recently registered point.

NOTES:

- There must be at least one second between an in-point and its corresponding out-point.
- To ensure correct operation, there should be at least 15 seconds between an out-point and the next in-point.
- Blank portions of a tape cannot be registered as in-points or out-points.
- If it takes more than 5 minutes to search for an in-point, the VCR's Record-Pause mode is cancelled and editing does not take place.
- Pressing **ON/OFF** clears all in- and out-points from memory.
- Leave a small margin for error around each in-point to ensure the scene is recorded in its entirety.
- Turning off the camcorder's power erases all registered in- and out-points.

Original tape (camcorder)

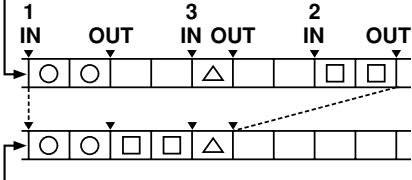

Edited tape (VCR)

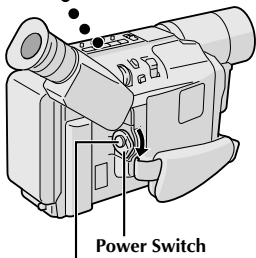
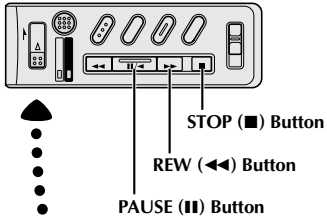

Recording Start/Stop Button

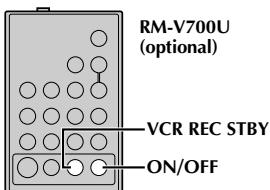
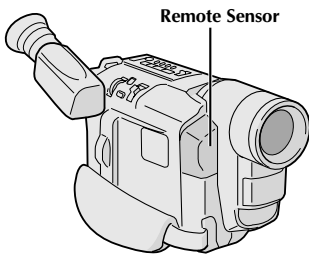

AUTOMATIC EDITING TO VCR

9 Rewind the tape in the camcorder to the beginning of the scene you want to edit and press **PAUSE**.

10 Point the remote control towards the VCR's infrared sensor and press **VCR REC STBY**, or manually engage the VCR's Record-Pause mode.

11 Press the Recording Start/Stop Button on the camcorder to begin Automatic Editing, and the previously selected scenes are copied to the VCR in the specified order.

While editing, the R.A. Edit counter of the scene which is being copied is shown with a blinking highlight.

- Pressing **START/STOP** on the remote control does not start editing.

12 When all selected scenes have been copied, the camcorder and VCR enter the Still or Pause mode. Press **STOP** on both units. To make the R.A. Edit counter display disappear, press **ON/OFF**.

- When finished editing, be sure to disconnect the editing cable and the A/V cable.

NOTES:

- If you performed step 1  on page 41 ("MAKE CONNECTIONS"), keep the remote control pointed at the VCR during editing.
- The on-screen display only appears while the camcorder searches for each scene.
- There may be noise at in- or out-points on the edited tape with certain VCRs.

ITEMS	NOTES
<p>⇒ Power (☞ pg. 6)</p>	<ul style="list-style-type: none"> ○ Perform charging where the temperature is between 10° and 35°C. 20° to 25°C is the ideal temperature range for charging. If the environment is too cold, charging may be incomplete. ○ Charging times noted above are for a fully discharged battery pack. ○ Charging time varies according to the ambient temperature and the status of the battery pack. ○ To avoid interference with reception, do not use the AC Adapter near a radio. ○ Since the AC Adapter processes electricity internally, it becomes warm during use. Be sure to use it only in well-ventilated areas. ○ The following operation stops charging or discharging: <ul style="list-style-type: none"> • Set the Power Switch to “PLAY”, “A” or “M”. • Disconnect the AC adapter from the camcorder. • Unplug the AC adapter’s power cord from the AC outlet. • Detach the battery from the camcorder.
<p>⇒ Date/Time Settings (☞ pg. 9)</p>	<ul style="list-style-type: none"> ○ The date/time cannot be stored in memory if the built-in clock battery runs out. Consult an authorized JVC dealer for replacement, or set the date/time as necessary before you start shooting.
<p>⇒ Recording (☞ pg. 14, 15)</p>	<ul style="list-style-type: none"> ○ When the Power Switch is set to “A” or “M” and the LCD monitor is opened at an angle of 60 degrees or more, the LCD monitor switches on and the viewfinder switches off automatically to save power. ○ The cassette holder cannot be opened unless a power supply is attached. ○ There may be a delay after you slide EJECT until the cassette holder opens. Do not use force. ○ The time required to calculate the remaining tape length, and the accuracy of the calculation, may vary according to the type of tape used. ○ The tape remaining time indicator is correct only if the correct tape length has been selected (☞ pg. 12). ○ “TAPE END” appears when the tape reaches its end, and the power goes off automatically if left in this condition for 5 minutes. “TAPE END” also appears when a cassette whose tape is already at its end is loaded. ○ If the Recording Start/Stop button is pressed after the Record-Standby mode has continued for over 5 minutes, recording may not start immediately. ○ While shooting, sound is not heard from the speaker.
<p>⇒ TBC (Time Base Corrector) (☞ pg. 31)</p>	<ul style="list-style-type: none"> ○ The “TBC” indicator turns green (grey with a camcorder equipped with a black/white viewfinder) while TBC is working. ○ TBC does not work during still playback and shuttle search. ○ The “TBC” indicator turns white while TBC is not operative. ○ It may take a few seconds before TBC actually starts working. ○ The picture may be distorted if the TBC mode is activated or deactivated at the edit-in/-out points or when normal playback resumes after still playback or shuttle search. ○ If the playback picture is distorted when TBC is set to on, turn off TBC.

Video Light



DANGER:

- The video light becomes extremely hot. Do not touch it either while in operation or soon after turning it off, otherwise serious injury may result.
- Do not place the camcorder into the carrying case immediately after using the video light, since it remains extremely hot for some time.
- When operating, keep a distance of about 30 cm between the video light and people or object.
- Do not use near flammable or explosive materials.
- It is recommended that you consult your nearest JVC dealer for replacing the video light.

General Battery Precautions

If the remote control or cassette adapter is not functioning even if it is being operated correctly, the batteries are exhausted. Replace them with fresh ones.

Use only the following batteries:

Remote control AAA (R03) size x 2 (RM-V715U)

Cassette adapter AA (R6) size x 1 (C-P6U or C-P7U)

Please make note of the following rules for battery use. When misused, the batteries can leak or explode.

1. When replacing batteries, refer to page 36 for the remote control, or read the cassette adapter (C-P6U/C-P7U) instructions.
2. **Do not** use any different size of batteries from those specified.
3. Be sure to install batteries in the correct direction.
4. **Do not** use rechargeable batteries.
5. **Do not** expose the batteries to excessive heat as they can leak or explode.
6. **Do not** dispose of the batteries in a fire.
7. Remove the batteries from the unit if it is to be stored for an extended period to avoid battery leakage which can cause malfunctions.

Battery Packs

The battery packs are nickel-cadmium or nickel metal-hydride batteries. Before using the supplied battery pack or an optional battery pack, be sure to read the following cautions:

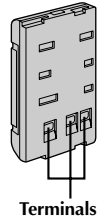

1. **To avoid hazard . . .**
 - ... do not burn.
 - ... do not short-circuit the terminals.
 - ... do not modify or disassemble.
 - ... use only specified chargers.
2. **To prevent damage and prolong service life . . .**
 - ... do not subject to unnecessary shock.
 - ... avoid repeated charging without fully discharging.
 - ... charge in an environment where temperatures are within the tolerances shown in the chart below. This is a chemical reaction type battery—cooler temperatures impede chemical reaction, while warmer temperatures can prevent complete charging.
 - ... store in a cool, dry place. Extended exposure to high temperatures will increase natural discharge and shorten service life.
 - ... avoid prolonged uncharged storage.
 - ... remove from charger or powered unit when not in use, as some machines use current even when switched off.

NOTES:

- *It is normal for the battery pack to be warm after charging, or after use.*
Temperature Range Specifications
Charging 10°C to 35°C
Operation 0°C to 40°C
Storage -10°C to 30°C
- *Recharging time is based on room temperature of 20°C.*
- *The lower the temperature, the longer recharging takes.*

Cassettes

To properly use and store your cassettes, be sure to read the following cautions:

1. During use . . .

- ... make sure the cassette bears the S-VHS-C or VHS-C mark.
- ... be aware that recording onto prerecorded tapes automatically erases the previously recorded video and audio signals.
- ... make sure the cassette is positioned properly when inserting.
- ... do not load and unload the cassette repeatedly without allowing the tape to run at all. This slackens the tape and can result in damage.
- ... do not open the front tape cover. This exposes the tape to fingerprints and dust.

2. Store cassettes . . .

- ... away from heaters or other heat sources.
- ... out of direct sunlight.
- ... where they won't be subject to unnecessary shock or vibration.
- ... where they won't be exposed to strong magnetic fields (such as those generated by motors, transformers or magnets).
- ... vertically, in their original cases.

Main Unit

1. For safety, DO NOT . . .

- ... open the camcorder's chassis.
- ... disassemble or modify the unit.
- ... short-circuit the terminals of the battery pack. Keep it away from metallic objects when not in use.
- ... allow inflammables, water or metallic objects to enter the unit.
- ... remove the battery pack or disconnect the power supply while the power is on.
- ... leave the battery pack attached when the camcorder is not in use.

2. Avoid using the unit . . .

- ... in places subject to excessive humidity or dust.
- ... in places subject to soot or steam such as near a cooking stove.
- ... in places subject to excessive shock or vibration.
- ... near a television set.
- ... near appliances generating strong magnetic or electric fields (speakers, broadcasting antennas, etc.).
- ... in places subject to extremely high (over 40°C) or extremely low (under 0°C) temperatures.

3. DO NOT leave the unit . . .

- ... in places of over 50°C.
- ... in places where humidity is extremely low. (below 35%) or extremely high (above 80%).
- ... in direct sunlight.
- ... in a closed car in summer.
- ... near a heater.
- ... in dusty places such as a beach.

4. To protect the unit, DO NOT . . .

- ... allow it to become wet.
- ... drop the unit or strike it against hard objects.
- ... subject it to shock or excessive vibration during transportation.
- ... keep the lens directed at extremely bright objects for long periods.
- ... direct the eyepiece of the viewfinder at the sun.
- ... carry it by holding the viewfinder or the LCD monitor. Be sure to hold the main unit with both hands or use the grip.
- ... swing it excessively when using the shoulder strap.

LCD Monitor

1. To prevent damage to the LCD monitor,

DO NOT . . .

- ... push it strongly or apply any shocks.
- ... place the camcorder with the LCD monitor on the bottom.

2. To prolong service life . . .

- ... avoid rubbing it with coarse cloth.

3. Be aware of the following phenomena for LCD monitor use. These are not malfunctions:

- While using the camcorder, the surface around the LCD monitor and/or the back of the LCD monitor may heat up.
- If you leave power on for a long time, the surface around the LCD monitor becomes hot.

About moisture condensation . . .

- You may have observed that pouring a cold liquid into a glass will cause drops of water to form on the glass' outer surface. This same phenomenon occurs on the head drum of a camcorder when it is moved from a cool place to a warm place, after heating a cold room, under extremely humid conditions or in a place directly subjected to the cool air from an air conditioner.
- Moisture on the head drum can cause severe damage to the video tape, and can lead to internal damage to the camcorder itself.

Serious malfunctioning

If malfunctioning occurs, stop using the unit immediately and consult your local JVC dealer.

For Your Maintenance

1. After Use

- ① Set the Power Switch to "OFF" to turn off the camcorder.
- ② Open the LCD monitor to an angle of over 60 degrees. Slide **EJECT** to open the cassette holder, then remove the cassette.
- ③ Close and lock the cassette holder by pressing the Close button.
- ④ Close and lock the LCD monitor.
- ⑤ Slide **BATTERY RELEASE** to remove the battery pack.
- ⑥ Attach the provided lens cap to the camcorder's lens.

2. Cleaning The Camcorder

① CLEAN EXTERIOR

Wipe gently with a soft cloth.
Put cloth in diluted mild soap and wring it well to wipe off heavy dirt, then wipe again with a dry cloth.

② CLEAN LCD MONITOR

Open the LCD monitor and wipe it gently with a soft cloth. Be careful not to damage the monitor. Close the LCD monitor.

③ CLEAN LENS

Blow it with a blower brush, then wipe it gently with lens cleaning paper.

④ REMOVE EYEPIECE

Turn the eyepiece counterclockwise and pull it out.

⑤ CLEAN VIEWFINDER

Remove dust using a blower brush.

⑥ RE-ATTACH EYEPIECE

Re-attach the eyepiece and turn it clockwise.

NOTES:

- Avoid using strong cleaning agents such as benzine or alcohol.
- Cleaning should be done only after the battery pack has been removed or other power units have been disconnected.
- Mould may form if the lens is left dirty.
- When using a cleaner or chemically treated cloth, refer to the cautions that came with it.
- When removing the eyepiece, be sure to hold the viewfinder securely.

If, after following the steps in the chart below, the problem still exists, please consult your JVC dealer.

The camcorder is a microcomputer-controlled device. External noise and interference (from a TV, a radio, etc.) might prevent it from functioning properly. In such cases, first disconnect its power supply unit (battery pack, AC Adapter, etc.); and then re-connect it and proceed as usual from the beginning.

SYMPTOM	POSSIBLE CAUSE(S)
POWER	
No power is supplied.	<ul style="list-style-type: none"> • The battery pack has not been attached correctly (☞ pg. 6). • The battery pack is not charged (☞ pg. 6). • The power supply has not been correctly connected (☞ pg. 6, 7).
The power suddenly goes off and does not come back on by itself.	<ul style="list-style-type: none"> • The battery pack has completely discharged. • Remove the cassette and disconnect the power source, then after a few minutes, try turning the power back on. If it still does not come on, consult your nearest JVC dealer.
RECORDING	
Recording cannot be performed.	<ul style="list-style-type: none"> • Make sure the Erase Protection tab is in the position that allows recording. If not, slide the tab. Some cassettes have removable tabs. If the tab has been removed, cover the hole with adhesive tape (☞ pg. 13).
Recording does not start.	<ul style="list-style-type: none"> • The camcorder Power Switch has not been set to "A" or "M" (☞ pg. 14).
Animation or Time-Lapse is not available.	<ul style="list-style-type: none"> • Before recording in the Animation mode at the very beginning of a tape, set the camcorder to the Recording mode for about 5 seconds, so that the tape runs smoothly. Using the Fade-in function at this point is a good way to begin an animated programme (☞ pg. 26, 37).
PLAYBACK	
The tape is running, but there is no playback picture.	<ul style="list-style-type: none"> • The TV has not been set to its VIDEO mode or channel. • If A/V connection is used, the TV's VIDEO/TV Switch has not been set to VIDEO.
Playback picture is blurred or interrupted.	<ul style="list-style-type: none"> • The video heads are dirty or worn out. Consult your nearest JVC dealer for head cleaning or replacement.
The counter indication is blurred during Still playback.	<ul style="list-style-type: none"> • This is normal.
TAPE TRANSPORT	
The tape stops during fast-forward or rewind.	<ul style="list-style-type: none"> • The Counter Memory Function has been activated (☞ pg. 31).
Rewinding or fast-forwarding cannot be performed.	<ul style="list-style-type: none"> • The tape is already fully wound on one reel or the other.

SYMPTOM	POSSIBLE CAUSE(S)
OTHER	
During recording, the indications do not appear.	<ul style="list-style-type: none"> ● Set “DISPLAY” to “FULL” in SYSTEM MENU (☞ pg. 24).
The tape will not eject.	<ul style="list-style-type: none"> ● The battery pack is running low. ● If the LCD monitor is not open over 60 degrees, the EJECT Switch does not function.
Some functions are not available.	<ul style="list-style-type: none"> ● The Power Switch is set to “A”. ● Certain combinations of modes or effects are not possible to use.
Vertical white lines appear when shooting a very bright object.	<ul style="list-style-type: none"> ● This sometimes occurs when the contrast between the background and the object is great. It is not a defect of the camcorder.
Bright, crystal-shaped spots appear in the LCD monitor and the viewfinder.	<ul style="list-style-type: none"> ● Sunlight is directly entering the lens. This is not a defect of the camcorder.
The rear of the LCD monitor is hot.	<ul style="list-style-type: none"> ● The light used to illuminate the LCD monitor causes it to be hot. Close the LCD monitor to turn it off or set the Power Switch to “OFF”, and let the unit cool down.
Coloured bright spots appear all over the LCD monitor or the viewfinder.	<ul style="list-style-type: none"> ● The LCD monitor and the viewfinder are made with high-precision technology. However, black spots or bright spots of light (red, green or blue) may appear constantly on the LCD monitor or in the viewfinder. These spots are not recorded on the tape. This is not due to any defect of the unit. (Effective dots: more than 99.99 %.)
The indicators and the picture colour on the LCD monitor are not clear.	<ul style="list-style-type: none"> ● This may occur when the surface or the edge of the LCD monitor is pressed.
The LCD monitor, the viewfinder and the lens have become dirty (ex. fingerprints).	<ul style="list-style-type: none"> ● Wipe them gently with a soft cloth. Gently wipe in a semicircular motion, as wiping strongly spreads the stain and it won't come out easily.
An error number (i.e. E03) appears.	<ul style="list-style-type: none"> ● Turn the camcorder's power off, then disconnect the power source. After a few minutes, try turning the power on again. If the error number still appears in the viewfinder, consult your nearest JVC dealer.
The image is out of focus.	<ul style="list-style-type: none"> ● The dioptre needs to be adjusted (☞ pg. 8). ● The scene being shot is adversely affecting the operation of Auto Focus (☞ pg. 28).
The date and time displays disappear.	<ul style="list-style-type: none"> ● If you remove the power source from the camcorder while the power is on, all settings and selections are erased. Make sure to turn the camcorder's power off before disconnecting the power source.
The wrong date and time are displayed/recorded.	<ul style="list-style-type: none"> ● If you have not performed Date/Time Setting (☞ pg. 9), the date and time are not displayed/recorded correctly. Be sure that Date/Time setting is carried out.
Even though the lens cap is detached, the “LENS CAP” warning indicator (☞ pg. 53) blinks.	<ul style="list-style-type: none"> ● The “LENS CAP” warning indicator may blink when the camcorder is used in dark areas, regardless of whether the lens cap is attached or detached.

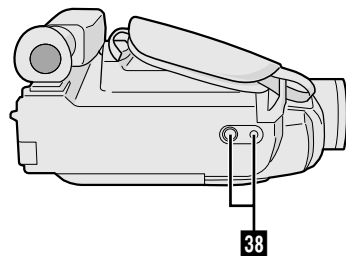
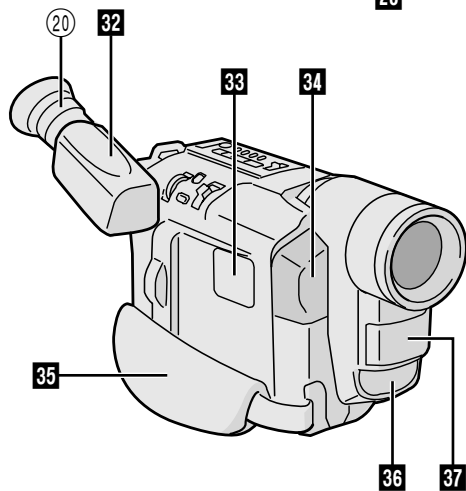
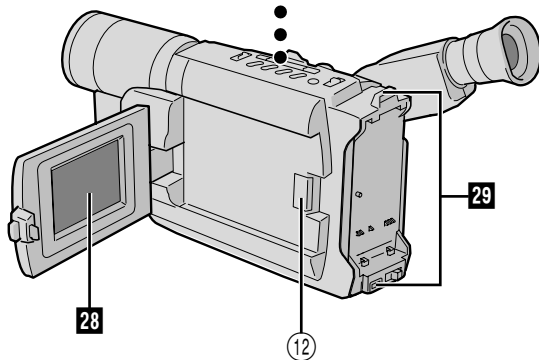
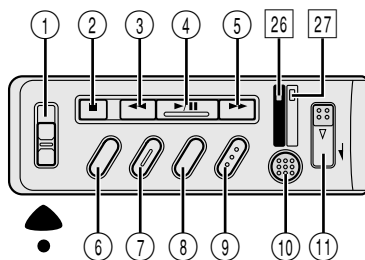
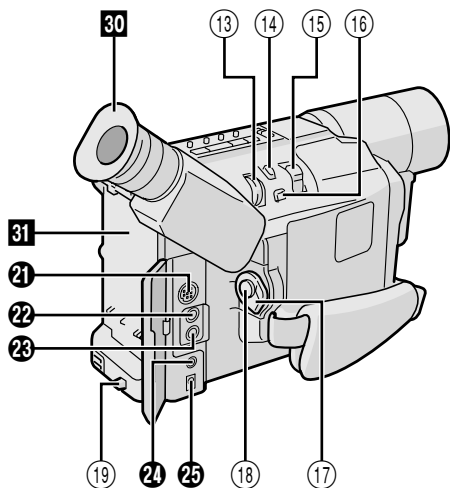

Controls

- ① Video Light Switch [LIGHT OFF/AUTO/ON] (GR-SXM607 only) pg. 17
- ② Stop Button [STOP] pg. 30
- ③ • Retake Rewind Button [RETAKE R] pg. 17
 - Quick Review Button [R] pg. 17
 - Rewind Button [R] pg. 30
- ④ Play/Pause Button pg. 30
- ⑤ • Retake Forward Button [RETAKE F] pg. 17
 - Fast-Forward Button [F] pg. 30
- ⑥ • Fade/Wipe Button [FADE/WIPE] pg. 19
 - Counter Reset/Memory Button [COUNTER R/M] pg. 31
- ⑦ Program AE Button [P. AE] pg. 20
- ⑧ Digital Effect Button [DIGIEFFECT] pg. 21
- ⑨ NIGHT-SCOPE Button pg. 18
- ⑩ REFRESH Button pg. 6
- ⑪ EJECT Switch pg. 13
- ⑫ Close Button pg. 13
- ⑬ • MENU Wheel [–, +] pg. 22
 - BRIGHT Wheel [–, +] pg. 14, 30
 - TRACKING Wheel [–, +] pg. 31
- ⑭ Snapshot Button [SNAPSHOT] pg. 18
- ⑮ • Power Zoom Lever [T/W] pg. 16
 - Speaker Volume Control [VOL.] pg. 30
- ⑯ • Picture Stabiliser Button [P. STABILIZER] pg. 16
 - Time Base Corrector Button [TBC] pg. 31
- ⑰ Power Switch [, OFF, ,] pg. 14, 30
- ⑱ Recording Start/Stop Button pg. 14
- ⑲ Battery Release Switch [BATTERY RELEASE] pg. 6
- ⑳ Dioptre Adjustment Control pg. 8

Connectors

The connectors ㉑ to ㉕ are located beneath the cover.

- ㉑ S-Video Output Connector [S] pg. 32
- ㉒ Audio Output Connector [A] pg. 32
- ㉓ Video Output Connector [V] pg. 32
- ㉔ J Terminal/Edit Connector [JLIP (Joint Level Interface Protocol)/EDIT]
 - Connect the editing cable when performing Random Assemble Editing (pg. 40 – 43).
 - It is used to connect the camcorder to a device such as a personal computer. For further details consult your nearest JVC dealer.
 - JLIP-controlled editing from camcorder to VCR is not possible if the VCR is not equipped with a J terminal.
- ㉕ DC IN Connector pg. 6, 7

Indicators

- ㉖ CHARGE Lamp pg. 6
- ㉗ • Power Lamp pg. 14
 - REFRESH Lamp pg. 6

Other Parts

- ㉘ LCD Monitor pg. 14, 15
- ㉙ Shoulder Strap Eyelets pg. 8
- ㉚ Eyepiece
- ㉛ Battery Pack Mount pg. 6
- ㉜ Viewfinder pg. 8
- ㉝ Speaker pg. 30
- ㉞ • Camera sensor
 - Be careful not to cover this area; a sensor necessary for shooting is built-in here.
 - Remote Sensor (GR-SXM607 only) pg. 36
- ㉟ Grip Strap pg. 8
- ㊱ Microphone pg. 39
- ㊲ Video Light (GR-SXM607 only) pg. 17
- ㊳ Tripod Mounting Socket pg. 8

Indications During Recording

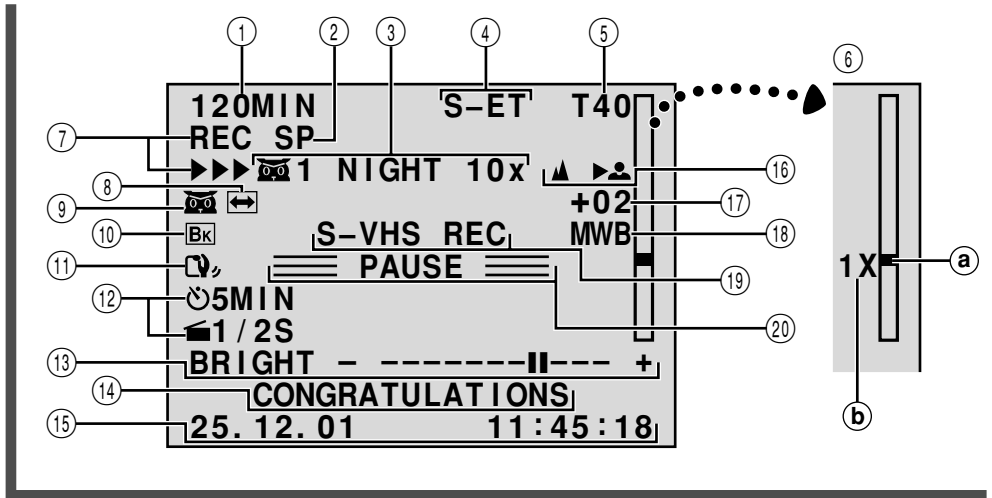

- ① Tape Remaining Time pg. 44
Blinks when a tape is about to reach its end.
- ② Recording Mode Indicator (SP/LP) pg. 12
- ③, ⑧ Digital Effect Indicator pg. 21
Displayed at ③ for approx. 2 seconds when the Digital Effect is switched from one mode to another by pressing **DIGIFECT**, then only the indicator remains at ⑧.
- ③, ⑨ • Program AE Indicator pg. 20
Displayed at ③ for approx. 2 seconds when Program AE with special effects is switched from one mode to another by pressing **P.AE.**, then only the indicator remains at ⑨.
- Night-Scope Indicator pg. 18
Displayed at ③ for approx. 2 seconds when Night-Scope is switched from one mode to another by pressing **NIGHT-SCOPE**, then only the indicator remains at ⑨.
- ③, ⑩ Fade/Wipe-Standby Indicator pg. 19
Displayed at ③ for approx. 2 seconds when the Fade/Wipe is switched from one effect to another by pressing **FADE/WIPE**, then only the indicator remains at ⑩.
- ④ Recording Format Indicator (S/S-ET) pg. 10
- ⑤ Tape Length Indicator pg. 12
- ⑥ Zoom Indicator Bar pg. 16
 Ⓐ Zoom Level Indicator
 Ⓑ Approximate Zoom Ratio
- ⑦ Recording Indicator pg. 14
- ⑪ Picture Stabiliser Indicator pg. 16
- ⑫ Interval Time/Recording Time Indicator pg. 26, 37
- ⑬ Bright Level Indicator pg. 14
- ⑭ Instant Title Display pg. 25
- ⑮ Date/Time Display pg. 25
- ⑯ Focus Indicator pg. 28
- ⑰ Exposure Control Level Counter pg. 27
- ⑱ White Balance Mode Indicator pg. 29
- ⑲ S-VHS/S-VHS ET Recording Indicator ... pg. 10
- ⑳ Record-Standby Mode Indicator pg. 14

Indications During Playback

- ① : Cassette Indicator
Displayed when a tape is loaded.
- : Insert Editing Indicator pg. 38
Displayed during Insert Editing.
- ② TBC Indicator pg. 31
- ③ Playback Special Effect Indicator pg. 31
- ④ Recording Format Indicator (S/S-ET) pg. 10
- ⑤ Tape Counter pg. 31, 38
- ⑥ Tape Running Indicator
▶ : Playback
▶▶ : Fast-Forward/Shuttle Search
◀◀ : Rewind/Shuttle Search
|| : Pause
◀▶ : Audio Dubbing
- ⑦ Tracking Indicator pg. 31
- ⑧ Tape Counter pg. 38
Displayed only during Insert Editing.
- ⑨ • BRIGHT:
Bright Level Indicator pg. 30
• VOLUME:
Speaker Volume Indicator pg. 30

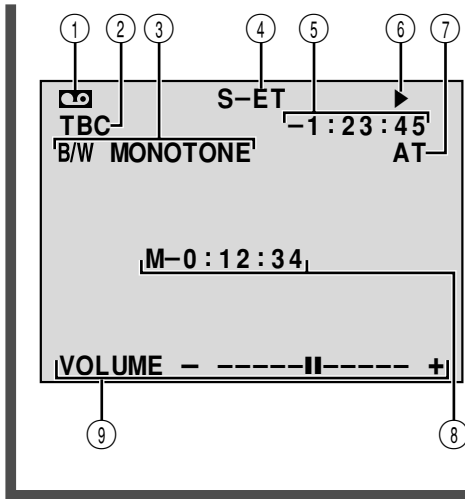

Warning Indications

Indications	Function
	<p>Displays the battery remaining power.</p> <p>Remaining power level: high. It does not necessarily mean that the battery pack is fully charged. </p> <p>Remaining power level: exhausted </p> <p>As the battery power comes close to nil, the battery indicator blinks (battery power warning). When the battery power is exhausted, power turns off automatically.</p>
	Blinks when no cassette is loaded, or when the Erase Protection tab is not in the position that allows recording. (pg. 13)
TAPE END	Appears when the tape ends during recording, playback or fast-forward. (pg. 44)
LENS CAP	Appears for 5 seconds after power is turned on if the lens cap is attached.
 CONDENSATION OPERATION PAUSED PLEASE WAIT	These 2 warnings appear alternately every 3 seconds if condensation occurs. In this case, all functions except tape eject and power on/off are disabled. Remove the tape, turn the unit off (without removing the power supply), wait a few minutes for the warnings to clear, and turn it on again.
 HEAD CLEANING REQUIRED USE CLEANING CASSETTE	These 2 warnings appear alternately every 3 seconds if dirt is detected on the heads during recording. In this case, use an optional cleaning cassette. If the warning remains after cleaning, consult your nearest JVC dealer.
E01—E06 UNIT IN SAFEGUARD MODE REMOVE AND REATTACH BATTERY	The error indications (E01 — E06) show what type of malfunction has occurred. If an error indication and warning appear, turn the unit off, remove the power supply (battery, etc.) and wait a few minutes for them to clear. When it does, you can resume using the camcorder. If the indication remains, consult your nearest JVC dealer.

A

AC Adapter	pg. 5, 6, 7
Animation Recording	pg. 26, 37
Audio Dubbing	pg. 39
Auto Date Record	pg. 25
Auto Focus	pg. 28
Auto Shut Off	pg. 15, 30

B

Battery Pack	pg. 6, 7, 45
Brighten The Image	pg. 27
Brighten The LCD Monitor	pg. 14

C

Cassette Adapter	pg. 34
Charge Marker	pg. 7
Charging The Battery Pack	pg. 6
Classic Film Mode	pg. 21
Clean The Camcorder	pg. 47
Connection To A VCR/TV	pg. 32
Contents	cover page
Counter Memory	pg. 31

D

Darken The Image	pg. 27
Darken The LCD Monitor	pg. 14
Date/Time Display	pg. 25
Date/Time Settings	pg. 9
Demonstration Mode	pg. 4, 24
Digital Effects	pg. 21
Digital Zoom	pg. 16, 23
Diopter Adjustment	pg. 8

E

Electronic Fog Filter Mode	pg. 20
Erase Protection	pg. 13
Exposure Control	pg. 27

F

Fade-In/Out	pg. 19
Fast-Forward Tape	pg. 30

G

Grip Adjustment	pg. 8
-----------------------	-------

H

High Speed Shutter Mode	pg. 20
-------------------------------	--------

I

Insert Editing	pg. 38
Instant Titles	pg. 25

J

JLIP ID NO.	pg. 24
Journalistic Shooting	pg. 15

L

LCD monitor/Viewfinder, Indications	pg. 52, 53
Load A Tape	pg. 13

M

Manual Focus	pg. 28
Menu Screen	pg. 22 - 24

Monotone Mode	pg. 21
Mosaic Mode	pg. 21

N

ND Effect Mode	pg. 20
Nega/Posi Mode	pg. 21
Night-Scope	pg. 18

P

Picture Stabiliser	pg. 16
Power Switch Position	pg. 14
Program AE With Special Effects	pg. 20
Provided Accessories	pg. 4

Q

Quick Review	pg. 17
--------------------	--------

R

Recording Format	pg. 10
Record-Standby	pg. 14
Remote Control	pg. 35
Retake	pg. 17
Rewind The Tape	pg. 30

S

Self-Recording	pg. 15
Sepia Mode	pg. 21
Shoulder Strap Attachment	pg. 8
Shuttle Search	pg. 30
Snapshot	pg. 18
Specifications	pg. 55
Sports Mode	pg. 20
Still Playback	pg. 30
Stretch Mode	pg. 21
Strobe Mode	pg. 21
Super VHS Expansion Technology	pg. 10

T

Tape Counter	pg. 31, 38
Tape Dubbing	pg. 32, 33
Tape Length Setting	pg. 12
Tele Macro	pg. 24
Time Base Corrector	pg. 31
Time-Lapse Shooting	pg. 26, 37
Tracking	pg. 31
Tripod Mounting	pg. 8
Twilight Mode	pg. 20

U

Unload A Tape	pg. 13
---------------------	--------

V

Video Echo Mode	pg. 21
Video Light	pg. 17
Viewfinder Adjustment	pg. 8

W

White Balance Adjustment	pg. 29
Wide Mode	pg. 23
Wipe-In/Out	pg. 19

Z

Zooming	pg. 16
---------------	--------

Camcorder

General

Format	: S-VHS/VHS PAL standard
Power source	: DC 11 V --- (Using AC Adapter) DC 6 V --- (Using battery pack)

Power consumption

Viewfinder on	: 4.0 W
LCD monitor on	: 4.5 W
Video light*	: 3.0 W

*GR-SXM607 only.

Signal system : PAL-type

Video recording system

Luminance	: FM recording
Colour	: Converted sub-carrier direct recording Conforms to VHS standard

Cassette :  /  cassette

Tape speed

SP	: 23.39 mm/sec.
LP	: 11.70 mm/sec.

Recording time (max.)

SP	: 60 minutes
LP	: 120 minutes (with EC-60 cassette)

Operating

temperature : 0°C to 40°C

Operating humidity : 35% to 80%

Storage temperature : -20°C to 50°C

Weight : Approx. 910 g
(GR-SXM607 only)
Approx. 900 g
(GR-SXM55 only)

Dimensions (W x H x D) : 200 mm x 112 mm x 118 mm
(with the LCD monitor closed
and with the viewfinder full
tilted downward)

Pickup : 1/4" format CCD

Lens : F1.6, f = 3.9 mm to 62.4 mm,
16:1 power zoom lens with
auto iris and macro control,
filter diameter 40.5 mm

Viewfinder : Electronic viewfinder with
0.5" black/white CRT

White balance adjustment : Auto/Manual adjustment

LCD monitor : 3" diagonally measured,
LCD panel/TFT active matrix
system (GR-SXM607 only)
2.5" diagonally measured,
LCD panel/TFT active matrix
system (GR-SXM55 only)

Speaker : Monaural

Connectors

JLIP/EDIT : ø3.5 mm, 4-pole, mini-head
jack (compatible with
RC-5325 plug)

Video : 1 V (p-p), 75 Ω unbalanced,
analogue output
(via Video output connector)

Audio : 300 mV (rms), 1 kΩ analogue
output
(via Audio output connector)

S-Video : **Y** : 1 V (p-p), 75 Ω,
analogue output
C : 0.29 V (p-p), 75 Ω,
analogue output

AC Adapter AP-V10EG



Power requirement : AC 110 V to 240 V \sim ,
50 Hz/60 Hz

Output : DC 11 V --- , 1 A

Dimensions (W x H x D) : 59 mm x 31 mm x
84 mm

Weight : Approx. 140 g
(not including Power Cord)

Optional Accessories

- Battery Packs BN-V12U, BN-V20U, BN-V400U
- Compact S-VHS () Cassettes SE-C45/30
- Compact VHS () Cassettes EC-60/45/30
- Remote Control Unit RM-V700U
- Active Carrying Bag CB-V7U
- Cassette Adapter C-P7U

Some accessories are not available in some areas.
Please consult your nearest JVC dealer for details on
accessories and their availability.